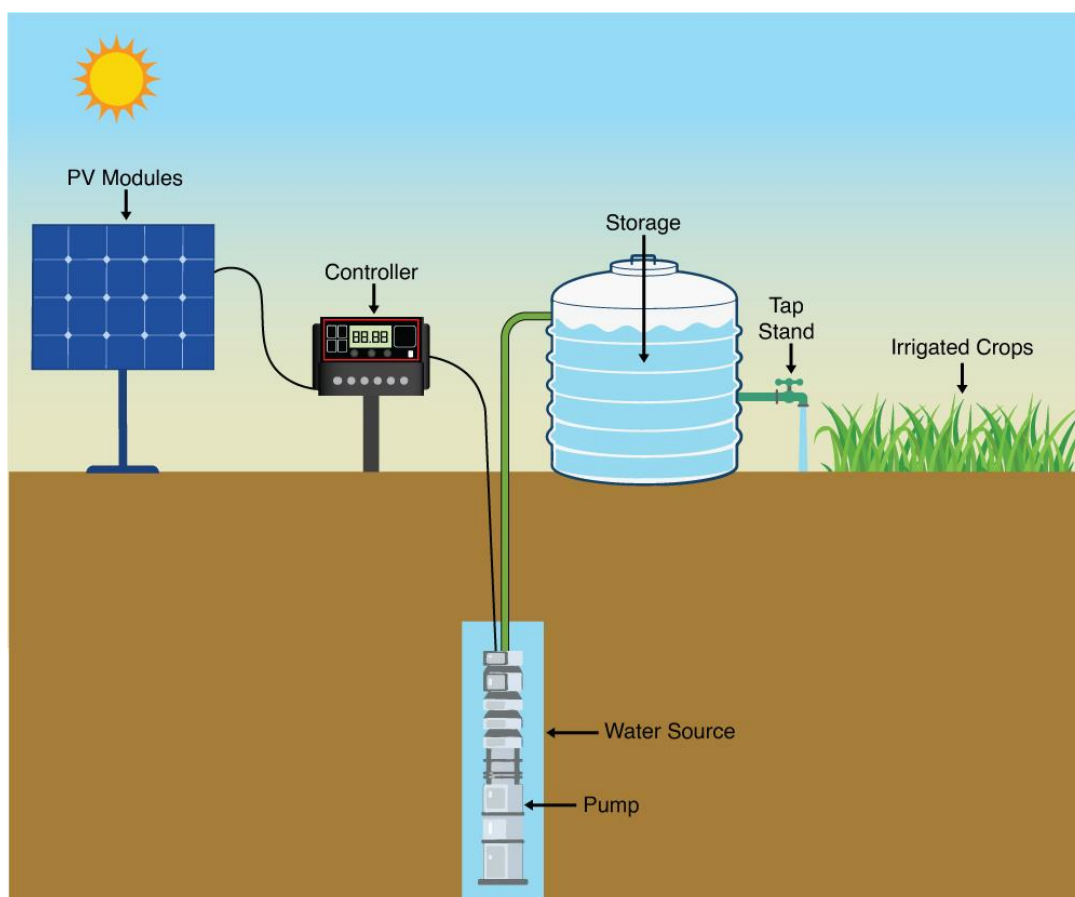


# **DRAFT STUDY MATERIAL**

## **Solar Pump Installation Technician**

(Job Role)



**Qualification Pack: Ref. Id. AGR/6701**

**Sector: Agriculture**

**Grade XII**



**PSS CENTRAL INSTITUTE OF VOCATIONAL  
EDUCATION, SHYAMLA HILLS, BHOPAL, M.P., INDIA**

© **PSS Central Institute of Vocational Education, Bhopal 2024**

No part of this publication may be reproduced, stored in a retrieval system or transmitted, in any form or by any means, electronic, mechanical, photocopying, recording or otherwise without the prior permission of the publisher.

## Preface

Vocational Education is a dynamic and evolving field, and ensuring that every student has access to quality learning materials is of paramount importance. The journey of the PSS Central Institute of Vocational Education (PSSCIVE) toward producing comprehensive and inclusive study material is rigorous and time-consuming, requiring thorough research, expert consultation, and publication by the National Council of Educational Research and Training (NCERT). However, the absence of finalized study material should not impede the educational progress of our students. In response to this necessity, we present the draft study material, a provisional yet comprehensive guide, designed to bridge the gap between teaching and learning, until the official version of the study material is made available by the NCERT. The draft study material provides a structured and accessible set of materials for teachers and students to utilize in the interim period. The content is aligned with the prescribed curriculum to ensure that students remain on track with their learning objectives.

The contents of the modules are curated to provide continuity in education and maintain the momentum of teaching-learning in vocational education. It encompasses essential concepts and skills aligned with the curriculum and educational standards. We extend our gratitude to the academicians, vocational educators, subject matter experts, industry experts, academic consultants, and all other people who contributed their expertise and insights to the creation of the draft study material.

Teachers are encouraged to use the draft modules of the study material as a guide and supplement their teaching with additional resources and activities that cater to their students' unique learning styles and needs. Collaboration and feedback are vital; therefore, we welcome suggestions for improvement, especially by the teachers, in improving upon the content of the study material.

This material is copyrighted and should not be printed without the permission of the NCERT-PSSCIVE.

Deepak Paliwal

(Joint Director)

Date: 25 Aug 2024

PSSCIVE, Bhopal

## **STUDY MATERIAL DEVELOPMENT COMMITTEE**

### Members

1. Mr. Prabhat Kumar Verma, Retired Assistant Commissioner, Olive 261, Ruchi Life, Jatkhedi, Hoshangabad Road, Bhopal – 462026
2. Dr. Uday R. Badegaonkar, Principal Scientist, Central Institute of Agricultural Engineering, Nabi Bagh, Berasia Road, Bhopal – 462038
3. Mr. Mukund Pandey, Principal Scientist, Central Institute of Agricultural Engineering, Nabi Bagh, Berasia Road, Bhopal – 462038
4. Dr. Manoj Mathew, Professor (FPME), Rice Research Station Moncompu, Alleppey, Kerala-688503
5. Manoj Darwai, Assistant Professor solar energy (Contractual), Department of Engineering and Technology, PSS Central Institute of Vocational Education, Shyamla Hills, Bhopal, M.P.
6. Er. Neeraj Bhandari, Assistant Professor, Civil, Contractual, Department of Engineering and Technology, PSS Central Institute of Vocational Education, Shyamla Hills, Bhopal, M.P.
7. Er. Ankit Singh Chouhan, Assistant Professor, Automobile, Contractual, Department of Engineering and Technology, PSS Central Institute of Vocational Education, Shyamla Hills, Bhopal, M.P.
8. Er. Kuber Singh, Ex. Assistant Professor (Contractual), Department of Engineering and Technology, PSS Central Institute of Vocational Education, Shyamla Hills, Bhopal, M.P.-462002
9. Dr. Satyendra Thakur, Assistant Professor, Agricultural Engineering (Contractual), Department of Engineering and Technology, PSS Central Institute of Vocational Education, Shyamla Hills, Bhopal, M.P.-462002
10. Er. Manoj Darwai, Assistant Professor Solar Energy, Contractual, Department of Engineering and Technology, PSS Central Institute of Vocational Education, Shyamla Hills, Bhopal, M.P.

### Member Coordinator

Saurabh Prakash, *Professor and Head*, Department of Engineering and Technology, Pandit Sunderlal Sharma Central Institute of Vocational Education, Bhopal, Shyamla Hills, Madhya Pradesh, India

**Table of Contents**

<i>Class XII</i>	
<b>Module 01: Installation and Commissioning of Solar Pumping System</b>	01
Session 01: Site Survey and Selection of Site	03
Session 02: Selection of Solar Water Pumping System	08
Session 03: Design Criteria for Solar Water Pump System	19
Session 04: Material requirement and Construction of the foundation for the solar water pump	32
<b>Module 02: Repair and Maintenance of Solar Pump</b>	49
Session 01: Cleaning and testing of solar panel	49
Session 02: Checking and identifying the different faults in the solar pumping system	58
<b>Module 03: Cost Economics of Solar Pump and Opportunities</b>	66
Session 01: Economics	66
Session 02: Business Strategies, Government Scheme and Policy	75
<b>Module 04: Innovation and Development in Solar Energy</b>	86
Session 01: Innovations in the field of solar energy products	86
Session 02: New Solar Technologies	94
<b>Answer key</b>	104
Abbreviation	108
Glossary	109
List of Credits	111

<b>Module 1</b>	<b>Installation and Commissioning of Solar Pumping System</b>
<b>Module Overview</b>	
<p>This module covers several key topics essential for designing and installing a Solar Pumping system. It begins with the process of conducting a thorough site survey and preparing a site feasibility report, which is crucial for assessing the suitability of a location based on factors such as sunlight availability, shading, and structural integrity. Students will then explore the selection and design of a Solar Solar Water Pumping System, learning how to choose the appropriate system size and components that meet the energy needs of the site while optimizing efficiency and cost. The module emphasizes the importance of understanding design features and their impact on the system's performance, reliability, and long-term maintenance.</p> <p>This module provides a comprehensive guide to the essential steps and best practices in designing and installing a Solar Water Pumping System. It covers everything from conducting site surveys to the final installation, ensuring that students are well-equipped to handle all aspects of a solar pump installation project.</p>	
<b>Learning Outcomes</b>	
<p>After completing this module, you will be able to:</p> <ul style="list-style-type: none"> <li>• Describe and perform the site survey and prepare site feasibility report</li> <li>• Identify and select the design of the Solar Water Pumping System</li> <li>• Describe the importance of design and evaluation features</li> <li>• List the material handling procedure</li> <li>• Construct the foundation for the Solar Water Pumping System unit</li> <li>• Describe the cable connection used in the solar installation</li> <li>• Installation of Mounting structure and Solar panel, pump</li> <li>• Discuss the quality parameters</li> </ul>	
<b>Module Structure</b>	
Session 01: Site Survey and Selection of Site	
Session 02: Selection of Solar Water Pumping System	
Session 03: Design Criteria for Solar Water Pump System	
Session 04: Material requirement and Construction of the foundation for the solar water pump	

## 1.1 INTRODUCTION

Photovoltaic (PV) panels are often used for agricultural operations, especially in remote areas or where the use of an alternative energy source is desired. In particular, they have been demonstrated time and time again to reliably produce sufficient electricity directly from solar radiation (sunlight) to power livestock and irrigation watering systems. A benefit of using solar energy to power agricultural water pump systems is that increased water requirements for livestock and irrigation tend to coincide with the seasonal increase of incoming solar energy. When properly designed, these PV systems can also result in significant long-term cost savings and a smaller environmental footprint compared to conventional power systems. The volume of water pumped by a solar-powered system in a given interval depends on the total amount of solar energy available at that time. Specifically, the flow rate of the water pumped is determined by both the intensity of the solar energy available and the size of the PV array used to convert that solar energy into direct current (DC) electricity.

Agricultural technology is changing rapidly. Farm machinery, farm building, and production facilities are constantly being improved. Agricultural applications suitable for photovoltaic (PV) solutions are numerous. These applications are a mix of individual installations and systems installed by utility companies when they have found that a PV solution is the best solution for remote agricultural needs such as water pumping for crops or livestock. A solar-powered water pumping system is made up of two basic components. These are PV panels and pumps. The smallest element of a PV panel is the solar cell. Each solar cell has two or more specially prepared layers of semiconductor material that produce direct current (DC) electricity when exposed to light. This Direct current (DC) is collected by the wiring in the panel. It is then supplied either to a DC pump, which in turn pumps water whenever the sun shines or stored in batteries for later use by the pump. Solar pumps are an important component of the solar off-grid programme as it provides reliable irrigation facility in rural/remote areas of the country. Solar photovoltaic water pumping systems can easily meet the irrigation requirements of land holdings for small and marginal farmers.

Therefore, solar pumps are being installed to replace the existing diesel pump used for irrigation.

## 1.2 NEED FOR DESIGNING AND INSTALLING SOLAR PUMP SYSTEM

Every solar water pump system is different. Every farmer is needed a different configuration type of solar water pumping system, designing a solar pumping system depends on water drawn from lakes, ponds, rivers, and bore well. When designing a solar pumping system, the designer must select the individual components of the solar water pump system as per the capacity planned for the system. A solar water pumping system consists of three major components: the solar array, pump controller, and electric water pump (motor and pump) In order to size and design a SWP (solar water pump system) system correctly, the following information is required for installer to design a PV-powered pump-in order to size and design a system correctly-

- ☞ How much water do you need
- ☞ When you need the water
- ☞ Whether your water source is a stream pond, spring, or well;
- ☞ Water available in gallons per minute (GPM);
- ☞ Well depth
- ☞ How far the water needs to be pumped and with what elevation gain;
- ☞ Water Quality Problems (Silt or High Mineral Content) That May Damage the Pump
- ☞ How Much Volume Is Available in Storage Tanks and How the Tanks Are Arranged.

Installing a solar pump is a systematic task, with various tasks such as selection of site, pouring concrete, elements of electrical work, plumbing, and heavy construction (often including earthmoving, welding, fastening, etc.)



Off-grid Solar PV applications programme is one of the oldest programmes of the Ministry of New and Renewable Energy (MNRE) aimed at providing solar PV-based applications in areas where grid power is either not available or is unreliable.

Under the PM-Kusum (Pradhan Mantri Kisan Urja Suraksha evam Utthaan Mahabhiyan) scheme, farmers running solar pumps from solar energy will be able to sell their electricity back to the power distribution units of the states and earn additional profit from it.

Though the scheme was implemented earlier, The Ministry of New and Renewable Energy under the central government has targeted to extend it till 2021-22 and 2022-23. The central government believes that PM Kusum Yojana can play an important role in doubling the income of farmers.

### **SESSION: 1**

#### **1. SITE SURVEY AND SELECTION OF SITE**

A site survey is a required step in the overall solar installation process. The site survey is necessary to design a correct and profitable solar energy generation system for the owner of the system. The location of solar panels, their direction, orientation, and the potential of sunlight play an important role in determining the amount of energy you can generate from the sun.

In general, the following parameter are required for the site survey of a solar pump system-

- a. The Climate condition of the site**
- b. Type land and shadow-free**
- c. Location of solar PV array**
- d. Shade Analysis**
- e. Space availability**
- f. Size and location of existing electrical connection**
- g. Location for mounting solar system components**

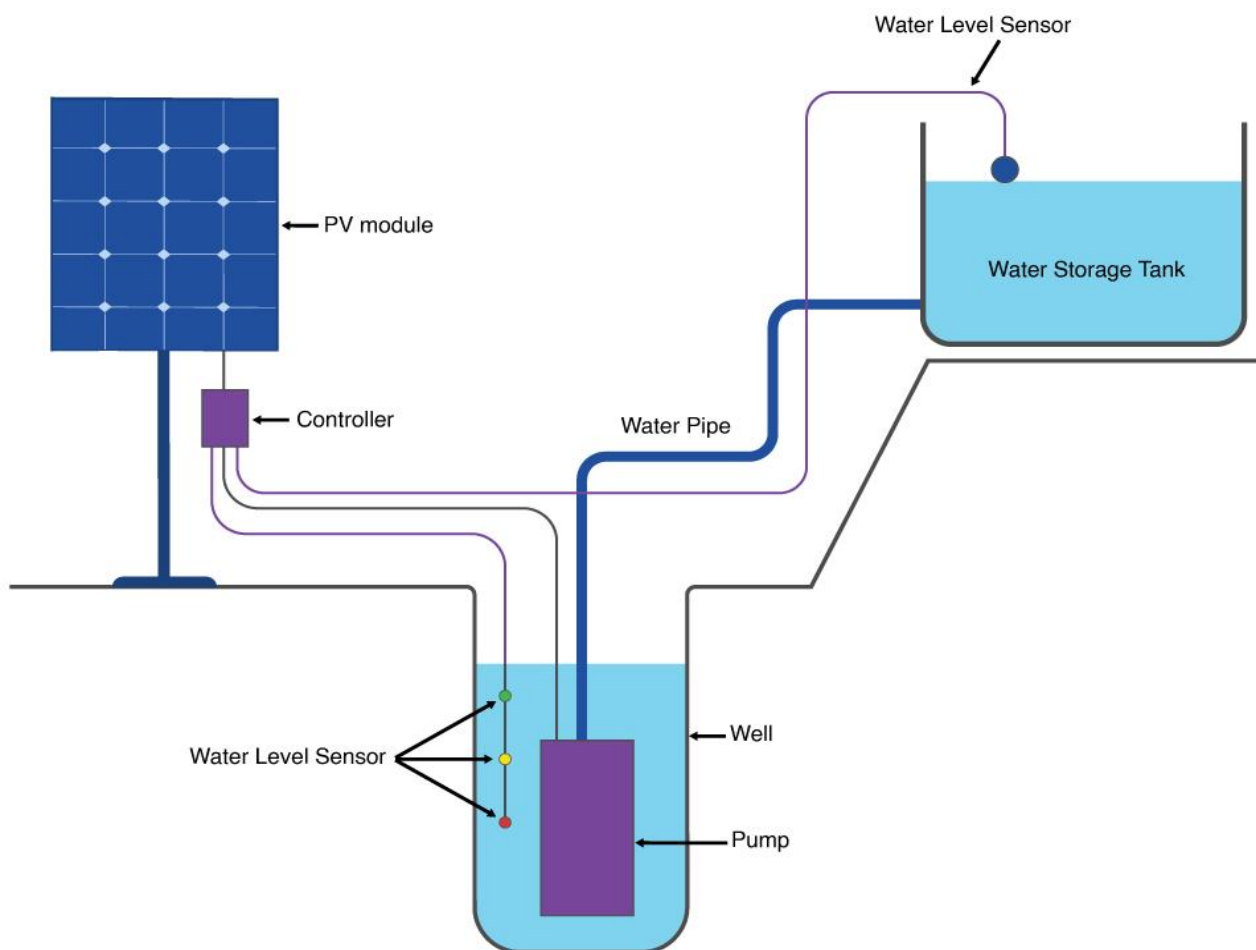
- a. The climate condition of the site:** The solar irradiation level, temperature, and variation in wind speed at the site provide an estimate of the potential for the solar PV installation and the specific components required. For instance, at low solar

irradiation level sites, an efficient solar panel is required as compared to high solar irradiation sites. Similarly, solar panels work more efficiently in colder regions as compared to hotter regions. Also, the installation design of the solar system should consider the worst wind load on the panels and the structure they are placed on.

- b. Type of land:** Defining the type of land and their soil is capable for foundation work, site soil is bearing a load of the structure, and solar panel it is required for the design of the solar system. The type of roof is also important as there can be various types such as RCC (Reinforced Cement Concrete), Metal sheet, Aluminum sheet, and Asbestos sheets. A roof can be flat or sloping with a specific potential to carry the weight of panels so this helps determine many other factors dependent on this information.
- c. Location of solar PV array:** It is important to determine the ideal solar PV array during the site survey. South, southeast, and southwest are three directions of the property where a solar PV array can be installed.
- d. Shade Analysis:** Ideally, the location where the solar PV array is to be installed should be shadow-free. During the site survey, any obstructions such as adjacent buildings, trees, water tanks, dish antennas, parapet walls, etc. should be noted as any obstacles can cause shade which can impact electricity generation. Shadow analysis is done to ensure maximum sunlight is captured throughout the year during the time frame of 9:00 am to 3:00 pm.
- e. Space Availability:** The space needed for a 1kW solar system is 80 sqft. So for a 10 kW system, the space needed is 800-1000 square feet During the site survey, the potential area is measured on the roof or the ground, and on this basis, the solar PV system is designed. The structure and type of roof (flat or slope), its direction, nearby obstructions, and its accessibility impact the location where the solar PV array is to be installed.
- f. Size and location of existing electrical connection:** To get the correct information on the size and location of the connection it is necessary to answer the few questions. Is it a single-phase or a three-phase electrical connection? At what voltage and frequency electricity is supplied to the property? Where is the main connection of the property to the electricity grid? These questions will help analyze the site survey better.

**g. Location for mounting solar system components:** Once the ideal location of the PV installation is decided, the location and diagram of mounting other components are to be specified in the site survey. Factors such as the distribution box, the inverter, and the wiring route of the whole system should be determined as well. If the installation is off-grid, the placement of the battery is also necessary.

After the site survey, we should be drawn a line diagram with scaling (dimensions)



**Fig. 1.1:** Typical layout of submersible SPV (solar photovoltaic) water pump set

### PERFORMANCE EVALUATION OF SOLAR WATER PUMPING SYSTEMS

Solar system performance is often difficult to accurately predict the system performance. Every installation tends to be unique which also makes the system

performance difficult to predict accurately. Due to this, we have developed a range of tools to optimise the performance of our Solar Pump Systems.

The solar photovoltaic-based agricultural water pumping system is the best-suited technology for the irrigation of farms. One of the agricultural-based applications of the solar photovoltaic system is water pumping for irrigation. Though the quantity and timing of irrigation may not match with the solar insolation, the pumped water can be stored and irrigated during the required periods. The performance evaluation of the solar pumping system can be carried out based on the solar insolation as input and pumped water as output.

The required data are

- **Average solar insolation ( $W/m^2$ ):** Solar insolation is the measurement of average daily solar radiation. It's stated as a daily value called insolation hours. The hours of insolation are equal to the average daily kilowatt-hours received per square meter. Average solar insolation is received in India 4-7 kWh per sq. m per day.
- **Average sun shine hours on the test day (hour):** Average sunshine hour in India depends on the location, but generally we count a 5-hour peak of sunshine for is counted the design purpose of the solar water pumping system.
- **Area of one SPV module ( $m^2$ ):** A PV module consists of many PV cells wired in parallel to increase current and in series to produce a higher voltage. 72-cell modules are the industry standard for large power production. As a thumb rule, a 10 square meter area for a 1 kW solar system capacity, is required.
- **Number of SPV modules:** number of the solar photovoltaic module depends on the pump and panel rating. For example, we install 7.5 hp solar dc pumps, now we required a 7kW capacity solar panel (330Wx21) for the motor run with a connecting with 7.5kW solar VFD.
- **Amount of water to be pumped/day or required water (liter/day or  $m^3/day$ ):** The amount of water required depends upon the purpose we have to use. Generally, the 7.5 hp motor pumped around 68000-150000 liter/day amount of water.

**Total head to be pumped (m):** The head is the height at which a pump can raise the fluid up and is measured in meters or feet.

## SESSION 1

### Practical Exercise

1. Describe the list of parameters for the site survey and selection of the solar pump system.
2. Draw the layout of the solar water pumping system.
3. List the components of the solar water pumping system.
4. Explain the advantages of the solar water pumping system.

### Check Your Progress

#### A. Short Answer Question

1. Explain the importance of solar insolation.
2. What is the minimum area required for a 1kw solar photovoltaic module?
3. Why shade analysis is necessary?
4. What are the average sunshine hours in India?

#### B. Fill in the blank

1. The full form of GPM is .....
2. 1 GPM is equal to .....
3. .... area is required for a 1 kW solar system capacity.
4. The average solar energy received in India is solar .....

**Answer. 1. Gallons Per Minute 2. 3.78 liters per minute 3. 10 sq meter.**

**4. 4-7 kWh per sq. m per day.**

#### C. Multiple choices question

1. A device used for measuring solar irradiance on a planar surface by measuring the solar radiation flux density (in units of  $W/m^2$ ), is
  - a) Pyranometer
  - b) Multimeter
  - c) Ammeter
  - d) Voltmeter
2. 1hp equal to?
  - a) 800 watts
  - b) 750 watts
  - c) 746 kW
  - d) 746 watts

3. S.I. unit of flow rate is

- a) ( $\text{m}^3/\text{s}$ )
- b) GPM
- c) Liter/day
- d) Liter/hour

4. The Head is the height at which a pump can raise fluid and is measured in

- a) feet
- b) meters
- c) a & b
- d) none of the above

#### ANSWER

1. a) Pyranometer 2. c) 746 watts 3. a) ( $\text{m}^3/\text{s}$ ) 4. c) a & b

### SESSION: 2

#### SELECTION OF SOLAR WATER PUMPING SYSTEM

A solar PV-based water-pumping system is an integration of different subsystems that can be grouped into electrical, mechanical, and electronics. Therefore, the synchronous operation of these components becomes vital in achieving better efficiency. The generalized structure of SPVWPS (solar photovoltaic water pumping system) comprises of solar PV array, a motor combined with a pump, and a power electronic interface. The size of the PV array required for water pumping is arrived at by considering several factors namely: location, temperature, solar insolation, water required per day, flow rate, head and so on.

#### MAIN COMPONENTS OF THE SWP SYSTEM

**Solar PV Array:** It consists of an array of solar panels connected in series and parallel combinations to achieve the desired voltage and current necessary to drive the ac pump. The power rating of the solar array will be suitable for the design of the pump. There are many types of solar panels and many denominations: monocrystalline,

polycrystalline, cadmium telluride (CdTe) and Amorphous Silicon (a-Si). All have advantages and disadvantages, different costs, and performance ratios. The solar panels used in the solar water pump systems produce electricity by using the photovoltaic effect. These solar panels absorb the sun's photons and convert them into energy. This is the main component of a solar water pump system.

**VFD/Controller:** Variable frequency drive (VFD) is a type of motor controller that drives an electric motor by varying the frequency and voltage of its power supply. The VFD also can control the ramp-up and ramp-down of the motor during start or stop, respectively.

A solar Pump Controller is an electronic device used for the uninterrupted operation of a solar pump. The controller is equipped with inbuilt MPPT (Maximum Power Point Tracking) and VFD MPPT helps to track maximum power points from PV modules. Variable Frequency Drive helps in the seamless operation of the motor under various weather conditions. The controller converts the DC power (DC voltage & current) of the PV array into a high or low DC voltage power or converts this DC power into single-phase or multi-phase alternating-current power (voltage or alternating current) suitably for driving the motor of the motor-pump set.

**Module Mounting Structure:** Mounting structures are the backbone of a solar power plant as they provide support to modules. These support structures raise solar panels at appropriate angles to ensure that they receive maximum solar irradiation. Without these, solar panels are not able to capture the required quantum of solar radiation for optimum solar generation

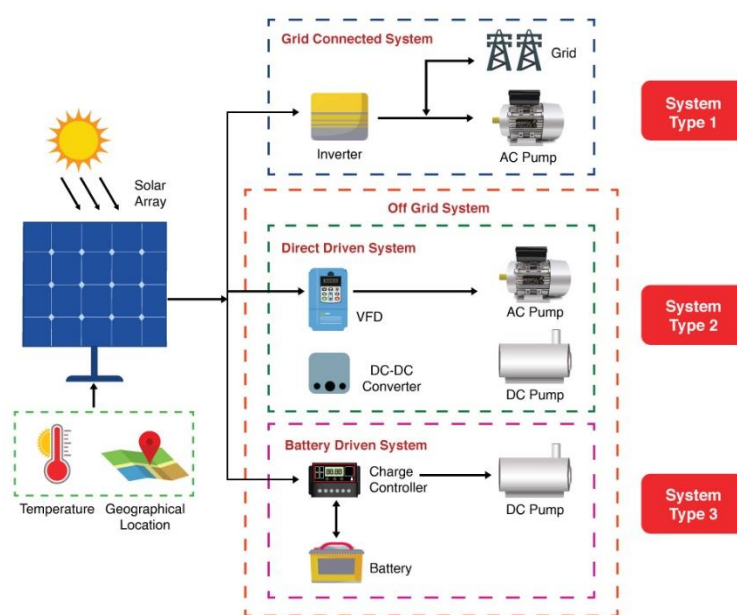
**Submersible Water Pump:**

A solar water pump is an innovative technology water lifting system that is powered by solar energy. It is also known as a solar pumping system, solar submersible pump, and solar pump.

The water pump is another part of the solar water pump system that is extremely important. Without the pump, you wouldn't have a water pump system. The pump is a piece of equipment that draws water from the source to be used for different applications. Water can be drawn from a well, pond, or other sources and used to help with agriculture, irrigation, and other settings. advanced solar pump system offers our pump both AC and DC power.

High-efficiency DC brushless motors are used in DC Solar Pumping system, Generated DC Power can directly supply to the DC motor. DC motors are made from permanent magnets which are responsible for high efficiency.

Generally, solar PV water-pumping systems can be categorized into grid-connected and off-grid systems. Off-grid systems are further subdivided into battery-driven and direct-driven systems.



**Fig. 1.2:** Generalized structure of solar PV water pumping system (SPVWPS)

**SYSTEM TYPE 1: GRID CONNECTED SYSTEM:** It is also known as a grid-tie or grid-feed solar system. These systems do not need batteries and use either solar inverters or micro-inverters and are connected to the public electricity grid. In an on-grid solar system, the water pump will be powered by a solar panel. In case the solar panel is generating more power than the water pump's consumption, then the excess power will automatically be exported to the grid via net metering and the government will adjust it in your next electricity bill.

Net metering is a billing mechanism that credits solar energy system owners for the electricity they add to the grid. For example, if a solar pump customer has a PV system on their land, it may generate more electricity than the pump uses during daylight hours. If the pump system is net-metered, the electricity meter will run backward to provide a credit against what electricity is consumed at night or



other periods when the home's electricity use exceeds the system's output. Customers are only billed for their "net" energy use. On average, only 20-40% of a solar energy system's output ever goes into the grid, and this exported solar electricity serves nearby customers' loads.

### **SYSTEM TYPE 2: OFF-GRID SYSTEM**

An off-grid system is not connected to the electricity grid. The off-grid Solar PV applications programme is one of the oldest programmes of the Ministry aimed at providing solar PV-based applications in areas where grid power is either not available or is unreliable. Solar pumps are an important component of the solar off-grid programme as it provides reliable irrigation facility in rural/remote areas of the country. Solar photovoltaic water pumping systems can easily meet the irrigation requirements of land holdings for small and marginal farmers. Therefore, solar pumps are being installed to replace the existing diesel pump used for irrigation.

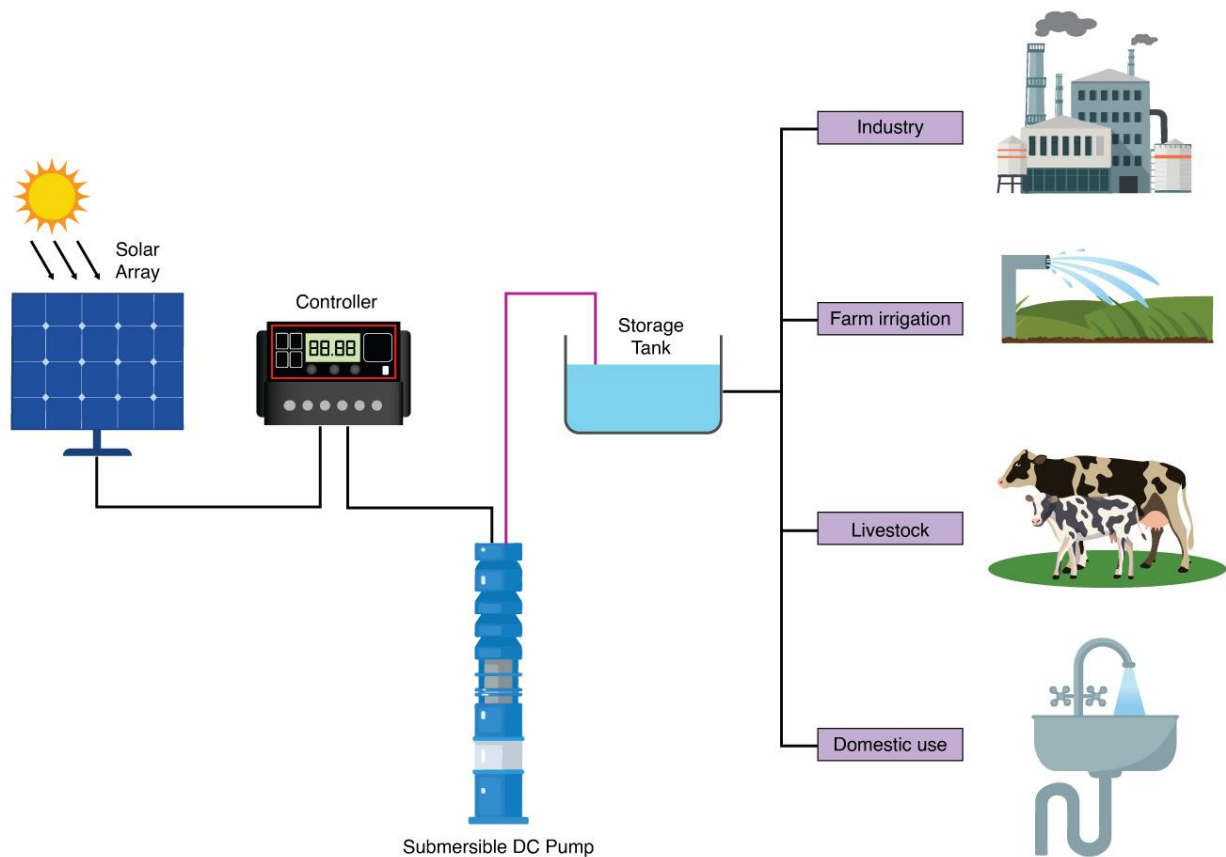
The government has recently launched a new scheme named Pradhan Mantri Kisan Urja Suraksha Evam Utthan Mahabhiyan (PM KUSUM) which aims to install new standalone solar pumps in off-grid areas and to solarize existing grid-connected agricultural pumps. This will provide farmers with a reliable source of irrigation, and increase farmers' income and their overall economic status and well-being.

### **SYSTEM TYPE 3 BATTERY-DRIVEN SYSTEM**

In this type of system, DC motor-driven the water pump is powered by a solar photovoltaic (SPV) array and battery storage. The SPV-battery-based hybrid generation is used as a power source to achieve continuous full-volume water delivery regardless of the climate condition. The SPV array is used as a primary source while the battery is a backup. Therefore, the battery is discharged only under bad climate conditions or at night when the PV array is insufficient to feed the water pump. Additionally, it is charged by the SPV array when water delivery is not required. Thus, no external supply is used for the battery charging.

The simplest method of SPVWPS (solar photovoltaic water pumping system) is by connecting the pump to the PV array via power converters without using batteries. Generally, battery-less SPVWPS is preferred for the fast recovery of

investment and to reduce the system cost. This arrangement consists of the solar array, controller, DC submersible pump, and usage of water as shown in Figure 1.3. A methodology is designed using a computer simulation that predicts the performance of a direct-coupled SPVWPS.



**Fig. 1.3:** Direct Driven System (off-grid system without battery)

The steps in selecting a solar water pumping system are summarised as follows:

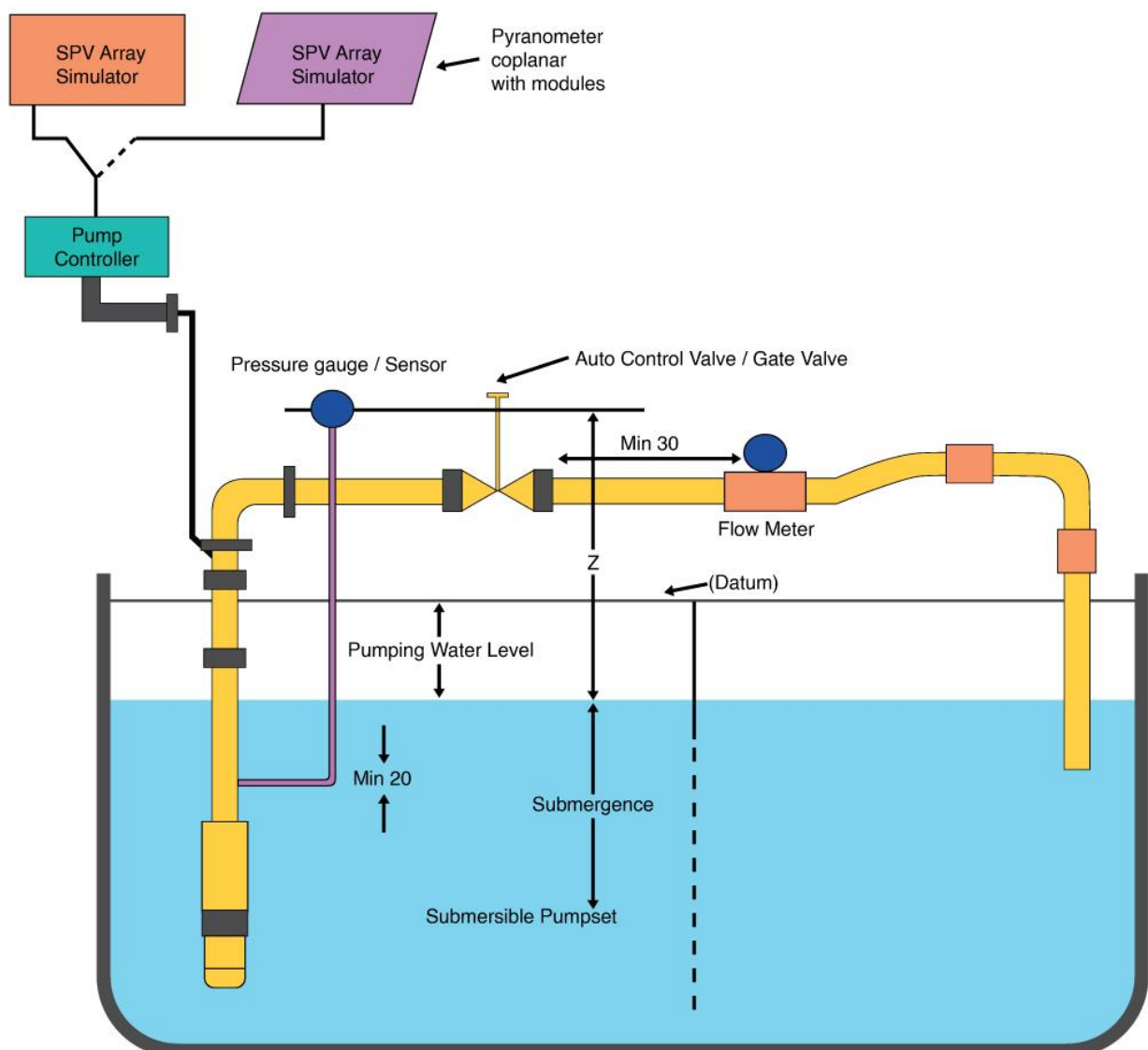
**1. During the site visit:**

- a.** Determine the water source and, based on the characteristics of the water source and the water's end usage, select the appropriate solar water pumping system to be installed.
  - b.** Determine the daily or weekly water requirement and verify that the water resource availability over the long term can meet the requirements.
  - c.** Determine where the solar array will be located.
  - d.** Determine where the water pump will be located.
  - e.** Determine the length of cables required between the solar array, pump controller and water pump.
  - f.** Determine where and how the water will be stored.
  - g.** Measure the static head for the site.
  - h.** Measure the total distance from the water source to the final location of the water.
  - i.** Determine and measure any land irregularities (hills, ditches, etc.) so that the piping system must traverse.
- 2.** Determine the solar irradiation for the selected site on an annual and monthly basis.
- 3.** Select the size and type of water pipe to be used to transfer the water from the source to its storage tank or its final destination if there is no storage tank.
- 4.** Estimate the expected dynamic head and select a possible solar water pumping system using either manufacturers' tables or an appropriate computer program, accounting for available solar irradiation. This will then provide information on the maximum flow rate.
- 5.** Use the estimated maximum flow rate and calculate the frictional losses (flow friction head) and determine the dynamic head.
- 6.** Choose a type of pump consistent with the quality of the water being pumped and the overall characteristics of the site (especially the particulate content of the water such as mud or coral sand),
- 7.** With the final calculated dynamic head finalise the selection of the solar water pumping system from the manufacturer's tables or data sheet. The table of the SWP system with technical specifications is shown in table no.1.1.1

8. After the Selection of the pump configuration, the Installation it.

### SOLAR WATER PUMPS (SWP):

In a solar water pumping system, the major aspect is the right selection of SWP. Nowadays various types of SWP systems are available in the market but it is very difficult to select the feasible and desired SWP system. so the solar technician should follow table no. 1.1,1.2 and 1.3 before buying the solar water pump system.



**Fig. 1.4:** Single-line diagram of the solar pumping system

In the solar market, AC submersible pumps or DC Submersible pumps are available but in most cases, DC submersible pumps are installed by the farmer.

solar water pump system design is depending on discharge rate, head, and power rating (ac/dc with different power ratings 1HP, 2HP 3HP 4HP 5HP 7.5HP 10HP etc.) while selecting the solar pumping system as per the requirements, the technician selects the pump (from the table number 1.1) which is required to the customer.

**Table no 1.1. Solar Panel and Pump Capacity**

Submersible Water Pumping System	Pump Capacity	Solar PV Module (Capacity) Watts	Total Head (Meter)
	1 HP	1200	30
	2 HP	1800	30-70
	3 HP	3000	50-70
	5 HP	5000	50-100
	7.5 HP	6750	50-100
	10 HP	9000	50-100

**Table no 1.2. Technical Specifications of Solar Submersible Pumping Systems with A.C. Induction Motor Pump Set**

Description	Model-I	Model II	Model-III	ModelIV	Model-V	ModelVI	ModelVII	ModelVIII	Model IX	Model-X	ModelXI	ModelXII	ModelXIII
PV array (Wp)	1200	1800	3000	3000	3000	4800	4800	4800	6750	6750	6750	9000	9000
Motor Pump-set capacity (HP)	1	2	3	3	3	5	5	5	7.5	7.5	7.5	10	10
Shut Off Dynamic Head (meters)	45	45	45	70	100	70	100	150	70	100	150	70	100
Water output * (Liters per day)	42000 (from a total head of 30 meters)	63000 (from a total head of 30 meters)	105000 (from a total head of 30 meters)	63000 (from a total head of 50 meters)	42000 (from a total head of 70 meters)	100800 (from a total head of 50 meters)	67200 (from a total head of 70 meters)	43200 (from a total head of 100 meters)	141750 (from a total head of 50 meters)	94500 (from a total head of 70 meters)	60750 (from a total head of 100 meters)	189000 (from a total head of 50 meters)	126000 (from a total head of 70 meters)

**Table no 1.3. Technical Specifications of Solar Deep well (submersible) pumping systems with D.C. Motor pumps Set with Brushes or Brushless D.C. (B.L.D.C.)**

Description	Model I	Model II	Model III	Model IV	Model V	Model VI	Model VII	Model VIII	Model IX	Model X	Model XI	Model XII	Model XIII
PV array (Wp)	1200	1800	3000	3000	3000	4800	4800	4800	6750	6750	6750	9000	9000
Motor Pump-set capacity (HP)	1	2	3	3	3	5	5	5	7.5	7.5	7.5	10	10
Shut Off Dynamic Head (meters)	45	45	45	70	100	70	100	150	70	100	150	70	100
Water output * (Liters per day)	45600 (from a total head of 30 meters)	68400 (from a total head of 30 meters)	114000 (from a total head of 30 meters)	69000 (from a total head of 50 meters)	45000 (from a total head of 70 meters)	110400 (from a total head of 50 meters)	72000 (from a total head of 70 meters)	50400 (from a total head of 100 meters)	155250 (from a total head of 50 meters)	101250 (from a total head of 70 meters)	70875 (from a total head of 100 meters)	20700 (from a total head of 50 meters)	13500 (from a total head of 70 meters)

For example, a farmer needed 1,00,000 liters /day of water and head approx. 40 meters, Model VI (5HP DC/AC PUMP) with the help of table number 1.2 and 1.3, is selected.

After selecting the solar pump rating of the system, we select the pump like the surface pump, submersible pump etc. most of the cases we installed two types of the solar pump.

### 1. Standalone Submersible solar pump

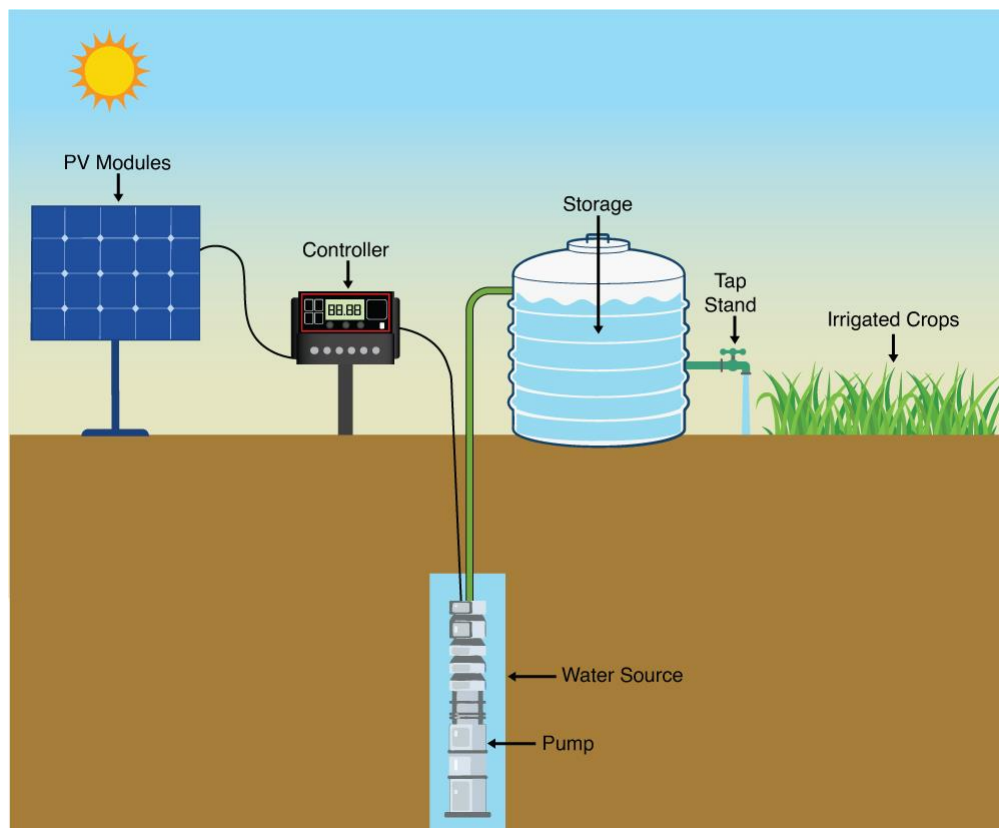
- a. Standalone AC submersible solar pump
- b. Standalone DC submersible solar pump

### 2. Standalone surface solar pump

- a. Standalone AC surface solar pump
- b. Standalone DC surface solar pump

## 1. STANDALONE SUBMERSIBLE SOLAR PUMP

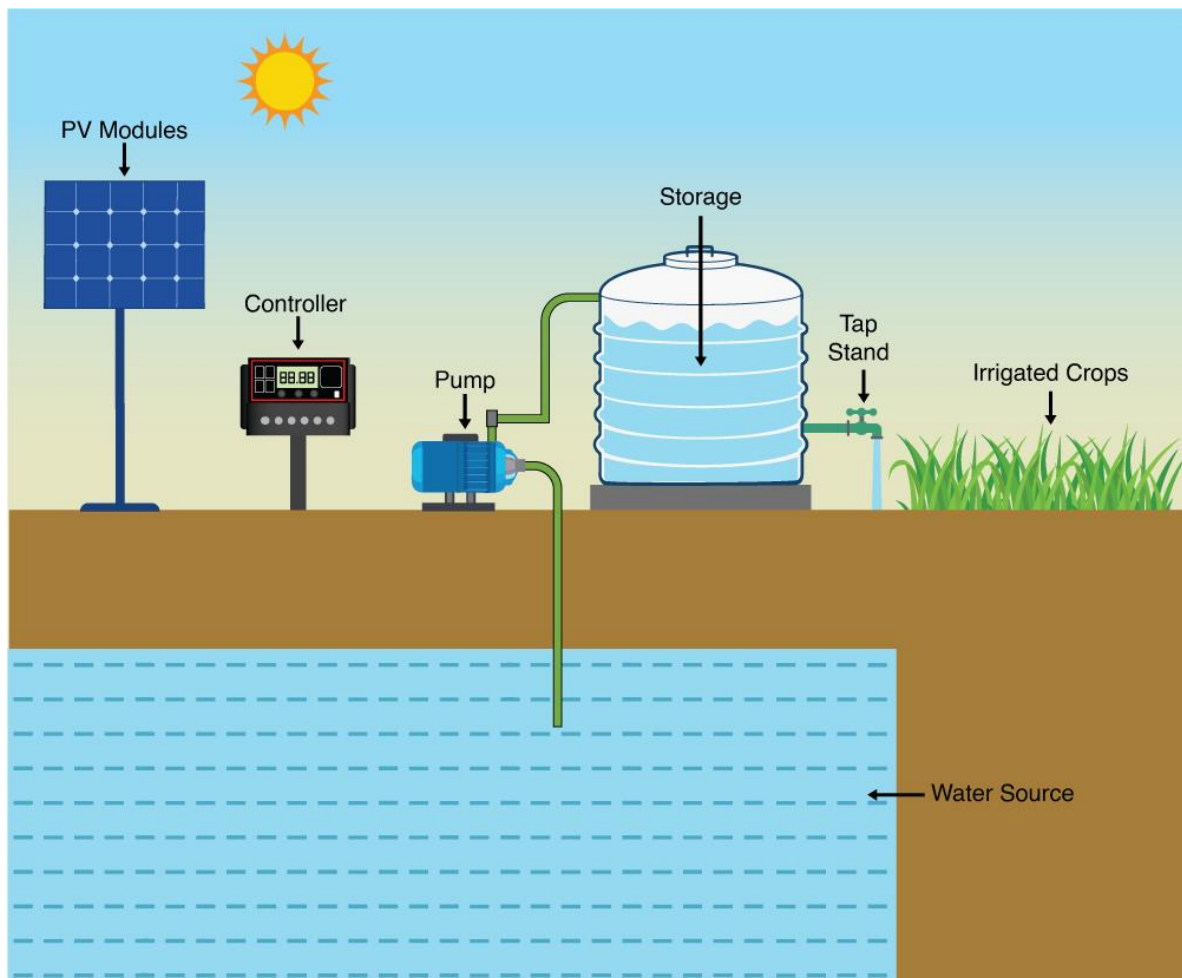
A stand-alone SWPS has solar as the only source of power. It consists of a PV array connected to a pump assembly via controller, as shown in figure no 1.5 The submersible configuration has a submersible pump installed completely submerged in the water source (mainly in wells and boreholes).



**Fig. 1.5:** Standalone submersible solar pump

## 2. STANDALONE SURFACE SOLAR PUMP

The surface configuration has the pump mounted outside and near the water source (e.g. tank, river, dam, lake). They are mounted at ground level with the inlet connected to the water source through a suction pipe and the outlet to the delivery pipe.



**Fig. 1.6:** Standalone surface solar pump

A DC pump system is the simplest SWPS configuration and consists of a PV array directly connected to a pump assembly with a DC motor via a DC controller. DC pumps have longer lifespans and are more efficient compared to an equivalent size of AC (up to 90 percent versus 50–70 percent for AC) as no power conversion is necessary. These pumps are, however, limited in head and flow and are generally



used for lower head, lower volume (i.e. smaller) applications of up to 4 kW power demand.

In an AC pump system, the PV array is connected to a pump assembly with an AC motor. The motor is typically a brushless 3-phase induction (asynchronous) motor. These motors have a robust design with standard or enhanced insulation providing long, reliable service, minimum maintenance and the ability to withstand the voltage stresses encountered with most inverter drives. AC motors cannot operate with DC power and require a DC-AC inverter to convert the incoming DC supply to power the AC pump. The pump design is commonly centrifugal due to its high flow capabilities. An AC pump system is used for higher-capacity applications that cannot be handled by a DC system.

### **SESSION: 02**

#### **Practical Exercise**

1. Draw the layout of the standalone submersible solar pumping system.
2. Make a table of solar water pumping systems based on head.
3. Construct a line diagram of the Direct Driven System (off-grid system without battery).

#### **Check Your Progress**

##### **A. Short Answer Question**

1. Why VFD is used?
2. Write the difference between AC/ DC Submersible Solar Pumps.
3. Short note on shade analysis?
4. Write a short note on net metering.
5. Explain the Grid-connected solar water pumping system.

##### **B. Fill in the blank**

1. The full form of VFD is .....
2. If we install the 7.5 HP Submersible water pumping systems solar module capacity is required .....
3. A solar pump controller is an electronic device used for..... operation of a solar pump.

4. The ..... also has the capacity to control the ramp-up and ramp-down of the motor during start or stop, respectively.

**Answer.1. variable frequency drive 2. 6750 watts 3. Uninterrupted 4. VFD**

### C. Multiple choices Question

1. Which type of pump operates with the help of variable frequency
  - a) AC submersible pump
  - b) DC pump
  - c) AC surface pump
  - d) a & c
2. Which type of solar water pumping system needs to be installed where grid power is not available?
  - a) Direct Driven SWP
  - b) On-Grid SWP
  - c) Hybrid SWP
  - d) None of the above
3. If we want to operate the water pump at night, which type of solar water pumping system will require?
  - a) Battery-driven SWP system
  - b) On-grid SWPS
  - c) Off-grid SWPS
  - d) None of the above
4. Invertor used in which type of SWP system
  - a) Battery-driven SWP system
  - b) On-grid SWPS
  - c) Off-grid SWPS
  - d) All of the above

### ANSWER

- 2. d) a & c 2. a) Direct Driven SWP 3. b) Battery driven SWP system**  
**3. b) on grid SWPS**

### **SESSION 3: DESIGN CRITERIA FOR SOLAR WATER PUMP SYSTEM**

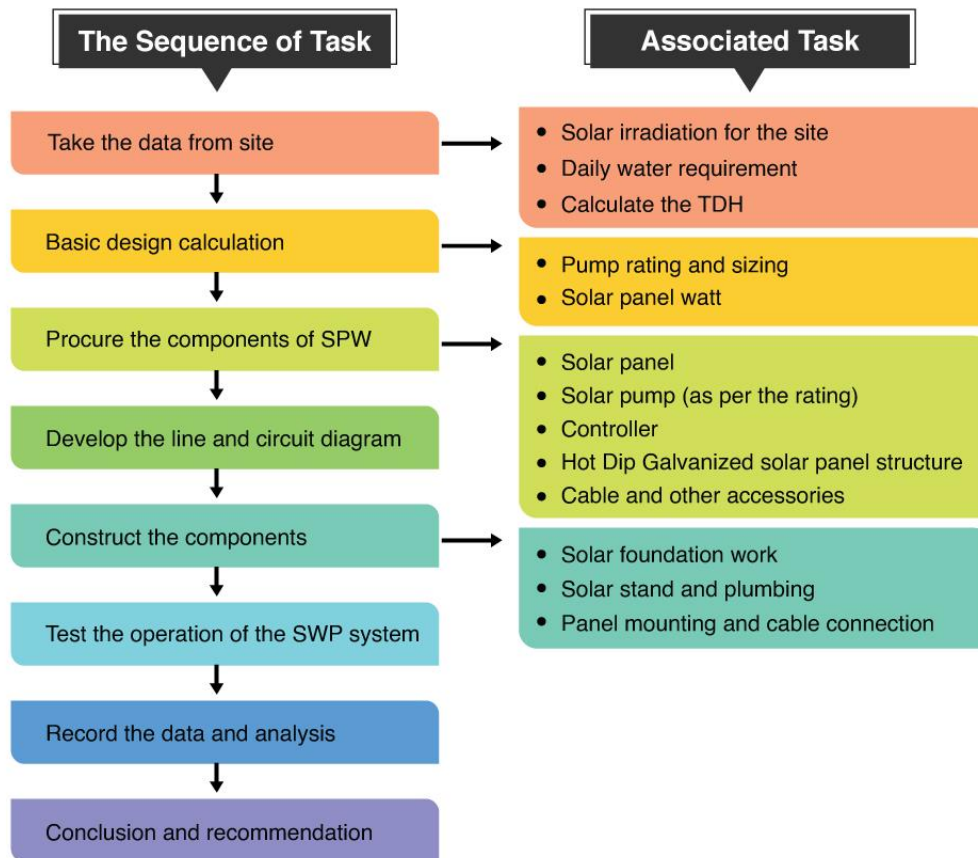
Solar water pumping systems are fundamental entities for water transmission and storage purposes whether it has been used in irrigation or residential applications. The use of photovoltaic (PV) panels to support the electrical requirements of these pumping systems has been executed globally for a long time. However, introducing the best sizing techniques to such systems can benefit the end-user by saving money, energy, and time. The design and evaluation have been carried out through intuitive and mathematical methods.

The following steps will be used in the design process for a solar water pump system. These steps will help you ensure that the system functions properly and that water is supplied for the operation in the amounts and at the locations required.

#### **The important parameters for solar installation and commissioning**

1. Site survey and selection of site
2. Calculation of the solar irradiation for the site
3. The volume of water required
4. Measurement of the static head
5. The quantity and quality of available water

6. Measurement of the length of the pipe required
7. Selection of the appropriate type of pipe and its diameter
8. Calculation of the total frictional losses (friction head) for the type, size and length of pipe used
9. Calculation the total dynamic head for the site and use the manufacturer's data sheets to select the most appropriate solar water pumping system:
10. The total dynamic head (TDH) for the pump
11. The system's proposed layout and hydraulic criteria

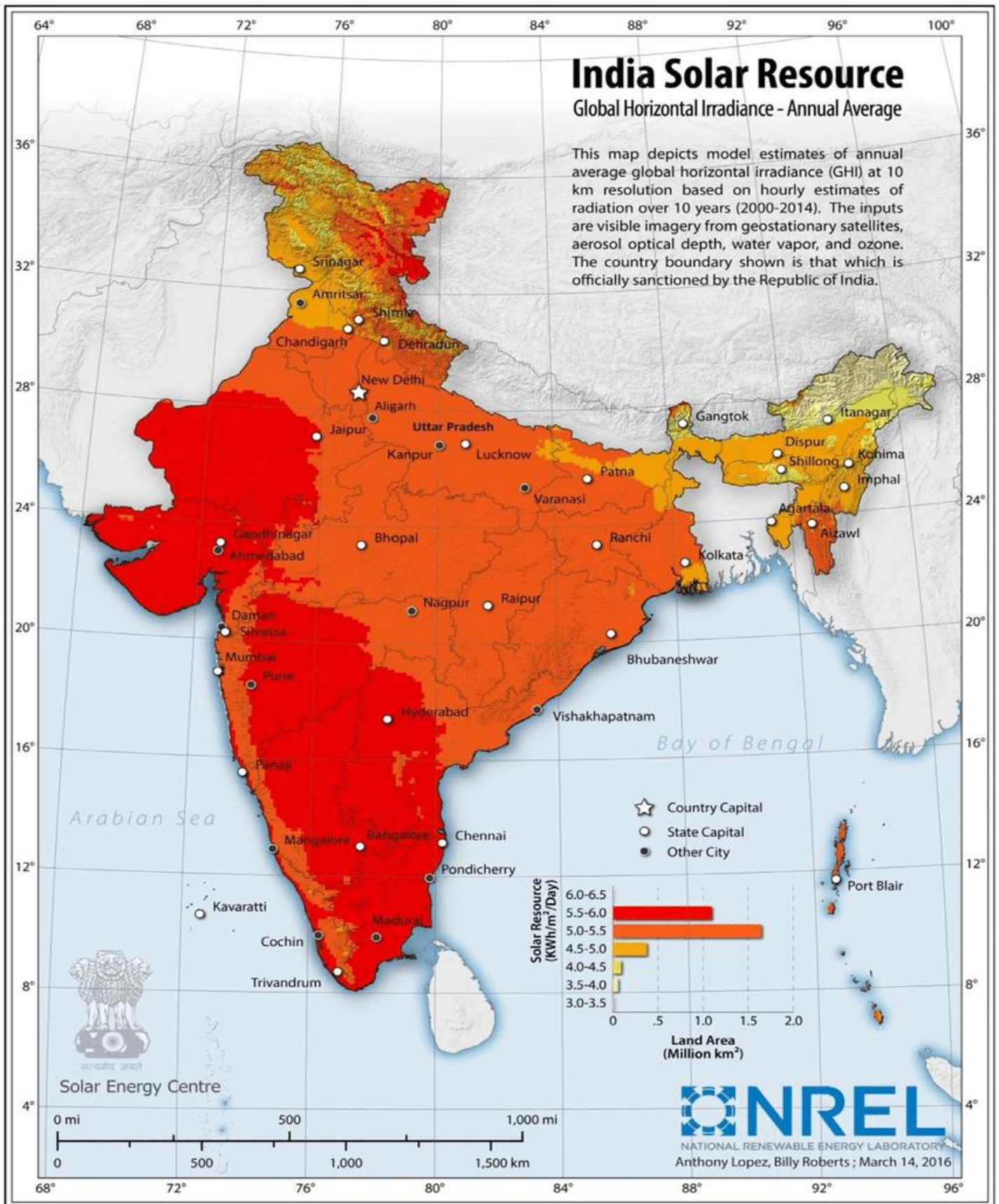


**Fig. 1.7:** Flow chart of Design and installation process of the solar water pumping system

### Design consideration:

#### Step 1. Determination of the solar irradiation for the site

The primary requirement for the design of any solar power project is accurate solar radiation data. It is essential to know the method used for measuring data for accurate design. Data may be instantaneously measured (irradiance) or integrated over some time (irradiation) usually one hour or a day. Data may be for beam, diffuse or total radiation, and for a horizontal or inclined surface. It is also important to know the types of measuring instruments used for these measurements. Radiation data for solar electric (photovoltaic) systems are often represented as kilowatt-hours per square meter ( $\text{kWh/m}^2$ ). Direct estimates of solar energy may also be expressed as watts per square meter ( $\text{W/m}^2$ ). Pyranometers are sensors that measure global shortwave radiation. Typical applications of silicon-cell Pyranometer include incoming shortwave radiation measurement in Agricultural, ecological and hydrological weather networks and solar panel arrays.



**Fig. 1.8: Solar Radiation Map of India**

Source: National Renewable Energy Laboratory (NREL)

The average solar Radiation in India is **5 kWh/m<sup>2</sup>/Day** and **We Count Average Hours of Radiation as 5 Hours per Day**





**Fig. 1.9:** Pyranometer

The professional solar radiation meter panel is designed with a "HOLD" button that supports maximum hold and data hold. Convenient for recording, user-friendly data comparison, and experimental investigation. Widely used for solar radiation measurement, solar energy research, meteorology, agriculture and physical and optical experiments. It can also be used to measure the light transmission intensity of glass to verify the performance of the glass, for example, a car window performance test.

India has a high potential for solar power generation of about 300 direct sunshine days per year. The regular solar incident in India varies with annual sunlight of **4 to 7 kWh/m<sup>2</sup>**. The Solar Radiation Map of India is shown in fig.1.8.

**Step 2. The amount of water required:** For domestic water supply, the first data needed is to estimate the water requirement per day. A good estimate can be found in "Basic water requirements for human activities: Meeting basic needs" which relates to how much water is required to sustain particular activities. Here is the estimate- for example, 12,000 liter/day (12 m<sup>3</sup>/day) of water is required and it also depends on the availability of water. If water is available, then the suction and discharge head will be calculated.

**Step 3. Calculate the pump rating:** After head calculation, the Pump horsepower will be calculated by using below the formula (Water horsepower or minimum power required to run the water pump)

$$\text{Water Horse Power (WHP)} = \frac{\text{Discharge (Q)} * \text{Total head (H)}}{3960}$$

**Discharge= Q (meter<sup>3</sup>/day)**

**Total head= H (meter)**

$$\text{Total Head } (H_{\text{Total}}) = \text{suction Head } (H_s) + \text{Delivery Head } (H_d)$$

Now the water flow rate in m<sup>3</sup>/hour will be calculated

Then,

Assume that the sun's peak hour is 5

Water flow rate in m<sup>3</sup>/hour = 12m<sup>3</sup>/ 5 hour

Water flow rate in m<sup>3</sup>/hour = 12 m<sup>3</sup>/ 5 hour

Water flow rate in m<sup>3</sup>/hour = 2.4 m<sup>3</sup>/hour

**Suction Head calculation** = Suction vertical Height (From Foot valve to Pump Centre) + Horizontal pipeline used + No of Bend (or) Elbow used in the suction pipeline

**Delivery Head calculation** = Delivery vertical Height (From Pump Centre to Overhead Tank) + Horizontal pipeline used + No of Bend (or) Elbow used in the Delivery pipeline.

For Example: Calculate the Size of the water pump having the following details

- Static Suction Head ( $h_2$ ) = 0 Meter
- Static Discharge Head ( $h_1$ ) = 50 Meters.
- Required Amount of Water ( $Q_1$ ) = 300 Liter/ Min.
- The density of Liquid ( $D$ ) = 1000 Kg/ M<sup>3</sup>
- Pump Efficiency ( $pe$ ) = 80%
- Motor Efficiency ( $me$ ) = 90%
- Friction Losses in Pipes ( $f$ ) = 30%

#### **SOLUTION:**

Now we are using this formula (HP) rating =  $Q \times H / 3960$

Flow Rate ( $Q$ ) =  $Q_1 \times 1.66 / 100000 = 300 \times 1.66 / 100000 = 0.005 \text{ m}^3/\text{Sec}$

Actual Total Head (After Friction Losses) ( $H$ ) =  $(h_1 + h_2) + ((h_1 + h_2) \times f)$

Actual Total Head (After Friction Losses) ( $H$ ) =  $50 + (50 \times 30\%) = 65 \text{ Meter}$ .

**Pump Hydraulic Power ( $ph$ ) =  $(D \times Q \times H \times 9.87) / 1000$**

**Pump Hydraulic Power ( $ph$ ) =  $(1000 \times 0.005 \times 65 \times 9.87) / 1000 = 3 \text{ KW}$**

**Motor/ Pump Shaft Power ( $ps$ ) =  $ph / pe = 3 / 80\% = 4 \text{ KW}$**

**Required Motor Size:  $ps / me = 4 / 90\% = 4.5 \text{ KW}$**

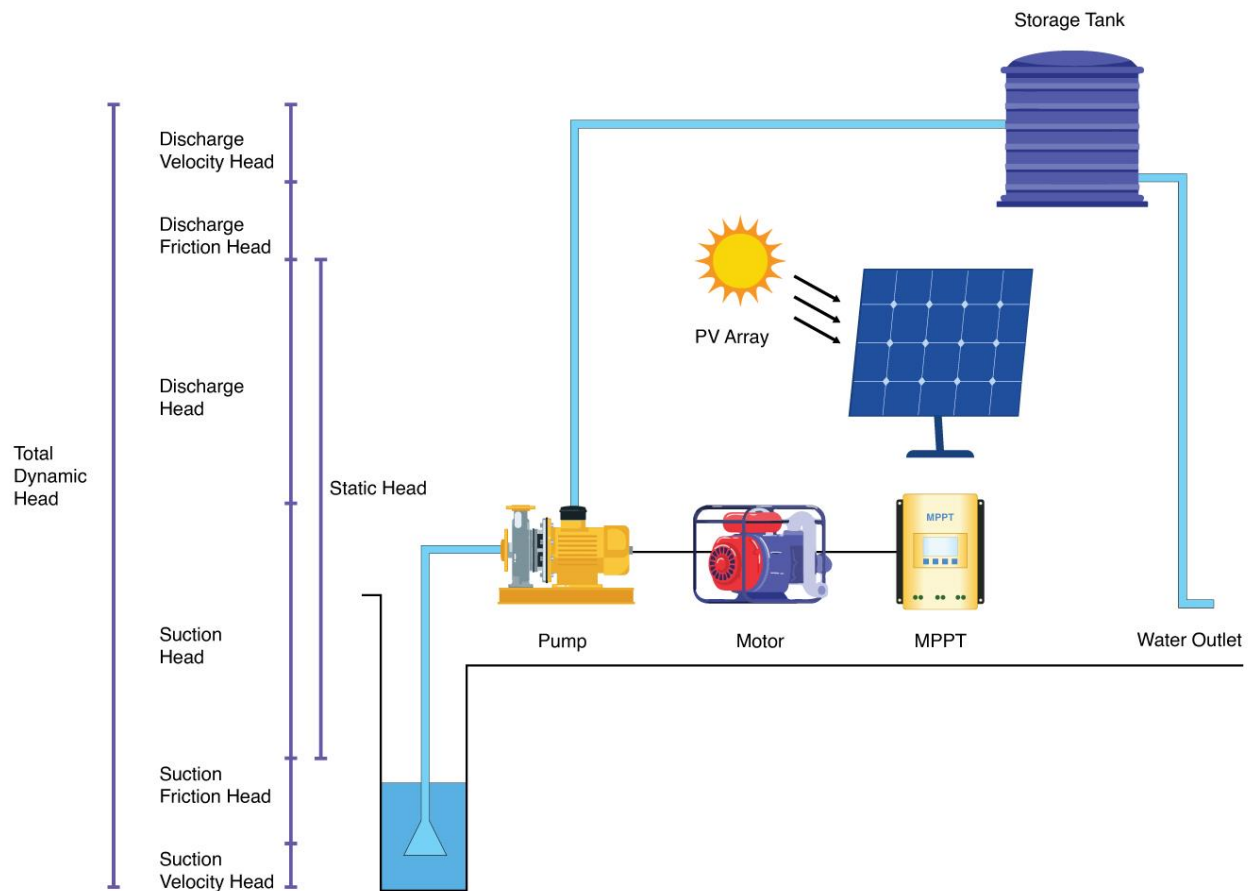
**So, the required minimum size of the pump is 6 HP  $\cong$  7.5 HP**

**We can match the above table.**



☞ **Solar radiation unit=kWh/m<sup>2</sup>/day**

☞ **Average solar radiation =5 kWh/m<sup>2</sup>/day (under Standard Test Conditions)**



**Fig. 1.10:** Total dynamic head of the solar pump

**4. Measuring the static head:** The static head is the vertical distance between the point where the pump obtains the water and the point where the pump discharges the water (shown in fig.no.1.10)

This can be specified as:

**Static head = Drawdown level + Static water level + Lift from surface**

**Drawdown:** Drawdown is the drop in the level of water in a well when water is being pumped. Drawdown measurements record the difference (in feet or meters) between the static level and the pumping level.

**Static water level:** Static level is the level of water in a well when no water is being taken from the well by pumps it is usually expressed as the distance in feet or meters from the ground surface to the water level.

**Lift from surface:** It is the level of water in the well during pumping, This, too, is usually expressed as the distance in feet or meters from the ground surface to the water level.

**5. The quantity and quality of available water:** The amount of water required each day or week will depend on the actual application. If the water is being used within a village, household, or resort then data should be available on the amount of water required per person in the village, household or resort. The designer might need to know the actual daily volume of water required. If the water is required for agricultural use, then the client should know their water requirements.

Example: Assume the required water requirements for a village are estimated at 45 liters (11.9 US gallons) per person. There are 200 people in the village. The required daily volume of water required is  $45 \times 200 = 9000$  liters or  $9 \text{ m}^3$  This data is used by the designer to select a solar water pumping system that will provide this volume of water per day. However, though this might be the required water volume, the designer must verify that the source can provide that volume of water consistently when using a solar pump that only operates during the day. This will be mostly dependent on the water resource though in some cases the solar resource may be a factor. Sometimes the actual water requirements may vary by month. If this is the case, then the maximum daily or weekly water requirements will need to be obtained and or determined in consultation with the client, and water needs calculated on a month-by-month basis and then, using the solar resource for each month, the solar pumping system will be determined.

**6. Measurement of the length of the pipe required:**

Pump the depth of the water pump in the borehole/well determines the length of the pipe between the pump and the surface. The designer shall measure the distance between the top of the borehole/well to the storage tank.

Hence the total length of water pipe required is the Distance from the top of the submersible pump to the top of the borehole/well + the distance between the borehole/well and the outlet at the storage tank.

**7. Selection of the appropriate type of pipe and its diameter:**

Select the size and type of water pipe to be used to transfer the water from the source to its storage tank or its final destination if there is no storage tank. The designer shall determine the total distance between the water resource and the location where the

pumped water is stored. This distance is required for determining the length of the water pipe required to move the water from the source to the storage tank. It is also used to determine the diameter of the water pipe required and frictional losses (frictional head) and ultimately the water pump and solar array rating. Note that the suction lift distance is limited by the type of pump being used and must be measured separately. pipe diameter is closely related to flow and distance. Horsepower  $H_p$  can give you an idea of flow, but it is best to get the rated flow of the pump to size the pipe. If the pump has a 50mm discharge pipe, it will likely be ok to get the water out of the well. Depending on the direction of the pipe and the total length, the shell be adjusted to the pipe size, so that gets good pressure at the end, and will be available.

**Table no.1.3 size the correct diameter pipe for the solar water pumping system.**

FLOW RATE		Nominal Pipe Diameter (in) / Actual Inside Diameter (in)										
GPM	LPM	1/2*	3/4	1	1 1/4	1 1/2	2	2 1/2	3	4	5	6
		0.662	0.82	1.05	1.38	1.61	2.07	2.47	3.07	4.03	5.05	6.06
1	3.8	1.13	0.14	0.05	0.02							
2	7.6	4.16	0.35	0.14	0.05	0.02						
3	11	8.55	2.19	0.32	0.09	0.05						
4	15	14.8	3.70	0.76	0.19	0.07						
5	19	22.2	5.78	0.81	0.25	0.12	0.04					
6	23	31.0	7.85	1.00	0.35	0.18	0.07	0.02				
7	27		10.6	1.52	0.46	0.23	0.08	0.03				
8	30		13.4	1.94	0.58	0.30	0.09	0.05				
9	34		16.9	2.43	0.72	0.37	0.12	0.06				
10	36		20.3	2.93	0.88	0.46	0.16	0.07	0.02			
11	42		24.3	3.51	1.04	0.53	0.18	0.08	0.03			
12	46		28.6	4.11	1.22	0.65	0.21	0.09	0.04			
14	53			5.47	1.64	0.85	0.28	0.12	0.05			
16	61			7.02	2.10	1.09	0.37	0.14	0.06			
18	68			8.73	2.61	1.34	0.46	0.16	0.07			
20	76			10.6	3.16	1.64	0.55	0.21	0.08	0.02		
22	83			13.3	3.79	1.96	0.67	0.25	0.09	0.03		
24	91			14.9	4.44	2.31	0.79	0.30	0.11	0.04		
26	99				5.15	2.66	0.90	0.35	0.14	0.05		
28	106				5.91	3.05	1.04	0.42	0.16	0.05		
30	114				6.72	3.46	1.18	0.46	0.18	0.06		
35	133				8.94	4.62	1.57	0.62	0.23	0.07		
40	152				11.0	5.91	1.99	0.79	0.30	0.09	0.02	
45	171				14.2	7.37	2.49	0.97	0.37	0.12	0.04	
50	190				17.3	8.96	3.03	1.20	0.46	0.14	0.05	
55	208					10.7	3.60	1.43	0.55	0.16	0.06	
60	227					12.5	4.23	1.66	0.65	0.18	0.07	0.02

Nominal Pipe Diameter (in) / Actual Inside Diameter (in)												
FLOW RATE		1/2*	3/4	1	1 1/4	1 1/2	2	2 1/2	3	4	5	6
GPM	LPM	0.662	0.82	1.05	1.38	1.61	2.07	2.47	3.07	4.03	5.05	6.06
65	246					14.5	4.90	1.94	0.74	0.22	0.08	0.03
70	265					16.7	5.64	2.22	0.85	0.25	0.09	0.04
75	284					19.0	6.40	2.52	0.97	0.28	0.10	0.05
80	303						7.31	2.84	1.09	0.32	0.12	0.06
85	322						8.06	3.19	1.22	0.37	0.13	0.07
90	341						8.96	3.62	1.36	0.39	0.14	0.08
95	360						9.91	3.90	1.50	0.44	0.016	0.09
100	379						10.9	4.30	1.66	0.49	0.18	0.12
150	569						23.1	9.10	3.51	1.04	0.37	0.16
200	758							15.5	5.98	1.76	0.62	0.28

NOTE: Values shaded in red are at velocities over 5ft per second and should be selected with caution.

### 8. Calculating the total frictional losses (friction head) for the type, size, and length of pipe used:

**Head Loss in a Pipeline:** When fluid flows inside a pipeline, friction occurs between the moving fluid and the stationary pipe wall. This friction converts some of the fluid's hydraulic energy to thermal energy. This thermal energy cannot be converted back to hydraulic energy, so the fluid experiences a drop in pressure. This conversion and loss of energy are known as head loss. The head loss in a pipeline with Newtonian fluids can be determined using the Darcy equation-

$$h_L = f \frac{L}{D} \frac{v^2}{2g} \quad \text{or} \quad h_L = 0.0311 \frac{f L Q^2}{d^3}$$

**Another standard “rule of thumb” is that friction losses in the pipe are typically 2–5% for a well-designed system.**

where:

$h_L$  = Head loss (feet of fluid)

$f$  = Darcy friction factor (unitless)

$L$  = Pipe length (feet)

$D$  = Inside pipe diameter (feet)

$v$  = Fluid velocity (feet/sec)

$g$  = Gravitational constant (32.2 feet/sec<sup>2</sup>)

$d$  = Inside pipe diameter (inches)

$Q$  = Volumetric flow rate (gallons/minute)

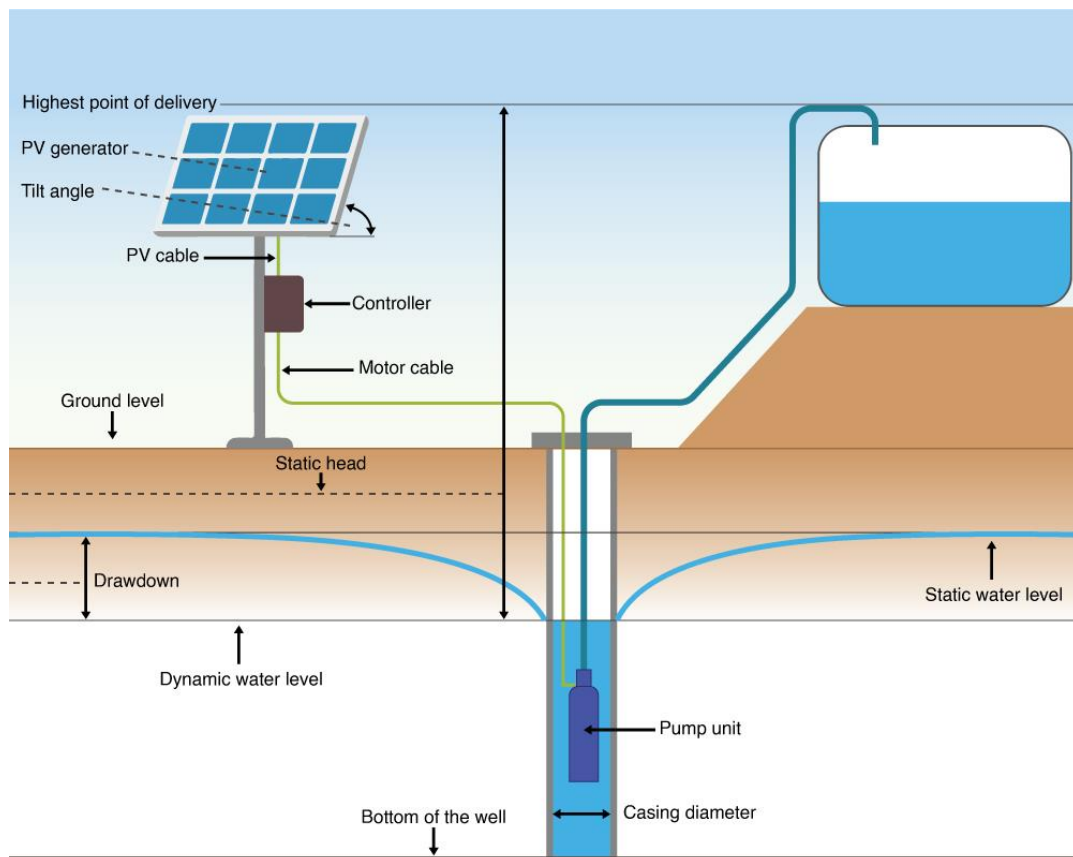
**9. Calculation of the total dynamic head for the site and using the manufacturer's data sheets or software to select the most appropriate solar water pumping system.**

**10. The total dynamic head for the pump:**

The total dynamic head is calculated based on the vertical height (static head) that the water must be pumped and the effective head caused by having to pump the design volume of water per unit time (gallons/minute or liters/minute) through the actual length and diameter of the pipe (frictional head) that is used to transport the water from the source to the final destination, often a water tank.

*Total dynamic head = static head + friction head of complete water piping system + velocity head at the discharge point.*

**11. The system's proposed layout and hydraulic criteria:**



**Fig.1.11:** layout and hydraulic criteria

A water pipe can be supplied as metal pipes, PVC pipes (hard plastic pipes), or polyethylene pipes (commonly known as poly pipes). Because of its flexibility poly pipe is often used with solar water pumping system.

**Example:** Calculate the Solar PV system for water pumping PV sizing, if water requirements are 25000 liters/day from a depth of 5m consider the frictional loss of 5% of total vertical lift (Total Dynamic Head) to determine the following:

a) Total Dynamic Head (TDH)

b) To determine estimated load requirement with selected DC pump [Experimental]

Different sizes of PV modules will produce different amounts of power. To find out the sizing of PV module, the total peak watt produced needs. The peak watt (WP) produced depends on the size of the PV module and the climate of the site location. to determine the sizing of the PV modules.

**Solution:**

First Step:

Water requirements = 25000 liters of water every day from a depth of 5m

Amount of water to be pumped/day = 25000 liter/day = 25m<sup>3</sup>

To determine Total Dynamic Head (TDH)

Possible max elevation of piping unit inlet = 3m

Possible max head of running stream fluctuates = 2m

Total vertical lift = 3m + 2m

= 5m

Possible frictional losses = 5% of total vertical lift

= 5 × 0.05

= 0.25

TDH= 5m + 0.25m =5.25m

To determine the estimated load requirement with selected DC

Pump [Experimental]

Selected DC pump max head = 7m

Selected DC pump max flow = 5m<sup>3</sup>/hour

Supplied voltage = 12V

No load current = 3A

Loading current = 14A

Power consumption, P = V×I = 12×14

= 168 Watt

Required running hour/day = 5 hour/day

**Required electrical energy/day = Power consumption \* Running hour/day**

Required electrical energy/day = 168Watt × 5hour/day

= 840-Watt hour/day

To determine the ampere-hour requirement of the DC load

System voltage = 12V

Load Current = 14A

## SESSION 3

### Practical Exercise

1. What are the parameters of the selection and design of the solar water pumping system?
2. Draw the Flow chart of the Design and installation process of the solar water pumping system
3. Explain TDH (Total dynamic head) with the help of a line diagram.

### Check Your Progress

#### A. Short Answer Question

1. What do you mean by the suction head?
2. Write a short note on the total dynamic head
3. What are the average sunshine hours in India?
4. Write the main components of the grid-connected solar water pumping system.

#### B. Fill in the blank

1. The static head of the pump is equal to..... of the suction head and delivery head.
2. Good pump efficiency means that a pump is .....in order to maintain its performance point.
3. ....is the vertical height of the liquid surface in the tank/reservoir to which the liquid is delivered.
4. Solar pump rating depends upon the .....

#### ANSWER

- 1) Sum 2) Not wasting energy 3) Delivery head 4) Total head and discharge

#### C. Multiple choices Question

1. The formula of energy required per day is equal to
  - a) Power consumption \* Running hour/day
  - b) Discharge(Q) \* Total head(H)/3960
  - c) Voltage(V) \* Current(I)
  - d) None of the above
2. What is the unit of energy head?
  - a) m
  - b) m/s
  - c) m<sup>3</sup>/s

d)  $m^2/s$

3. Formula Power is most commonly expressed as -

a) m

b) kW

c)  $m^3/s$

d) m/s

4. The formula of the static head of the solar water pump is equal to

a) Suction head + Delivery head

b) Static Water Depth + Drawdown + Additional Lift) + Frictional Losses in Pipe

c) Friction loss +delivery head

d) All of the above

**ANSWER**

1.a) 2.a) 3.b) 4.a)



## SESSION 04

### **MATERIAL REQUIREMENT AND CONSTRUCTION OF THE FOUNDATION FOR THE SOLAR WATER PUMP**

**Procurement of Raw Materials:** Material procurement is the process of researching, selecting, ordering, and paying for the raw materials required for constructing a building or structure. Procurement of any kind involves identifying and selecting vendors or suppliers, negotiating prices and terms, and awarding contracts.

Once the output is required from the system, you need to prepare a list of materials required for installation need to be prepared as per the specifications.

For installing solar arrays and system controllers:

- The manufacturer which provides the whole mechanism which includes solar modules/arrays, connecting cables, structures to fit in solar panels (mounting structure), standing pole structures, and an instruction manual, will be finalized.
- Always read the manufacturer's instructions to ensure the specificities.
- Check the guarantee period.
- Take into account the maintenance cost of the system you purchase.
- It is important to Check the compatibility of all parts if the items are purchased from a different manufacturer.
- Wiring of the solar panels in the array and with the system controller must be according to Indian standards. Wiring should be chosen such that it offers minimum electrical losses.
- all safety measures while handling electrical instruments like earthing, short circuits, etc must be considered.

#### **For the selection of pipes, pumps, and motors:**

- This selection will depend on the flow rates calculated.
- Whether it is a submersible or surface pump, it needs to be installed on a firm base and should have the right alignment.
- Place all the parts required for installation and follow the manufacturer's instructions.
- Piping needs to be done such that it is easy to maintain and replace when required without disturbing the whole system.
- Length and width of the pipes should be considered in advance.

#### **Procurement of Raw Materials**

For installing a solar panel system, the following materials need to be arranged

/purchased by the technician or vendor:

**Table No.4.1 List of Raw Materials**

<b>S.No.</b>	<b>Parts name</b>	<b>Specification</b>
1.	PV Panel	
2.	Earthing kit	
3.	VFD (variable frequency drive)/ controller	
4.	Circuit Breakers	
5.	Solar panel	
6.	Solar pump	
7.	Wiring Cable	
8.	Solar Panel structure, the main pole, made of metal frames, c channels	
9.	concrete material	
10.	paint to prevent corrosion	
11.	MC4 connector	
12.	junction box (AC or / DC)	
13.	Plumbing materials, pipes and Fittings	

**Minimum 5 years warranty for complete solar water pumping system and 25 years for solar panel needed**

### **Handling of various Equipment**

While installing the solar water pump or loading and unloading, solar technicians will come across many mechanical instruments. These instruments need to be handled carefully and with precautions.

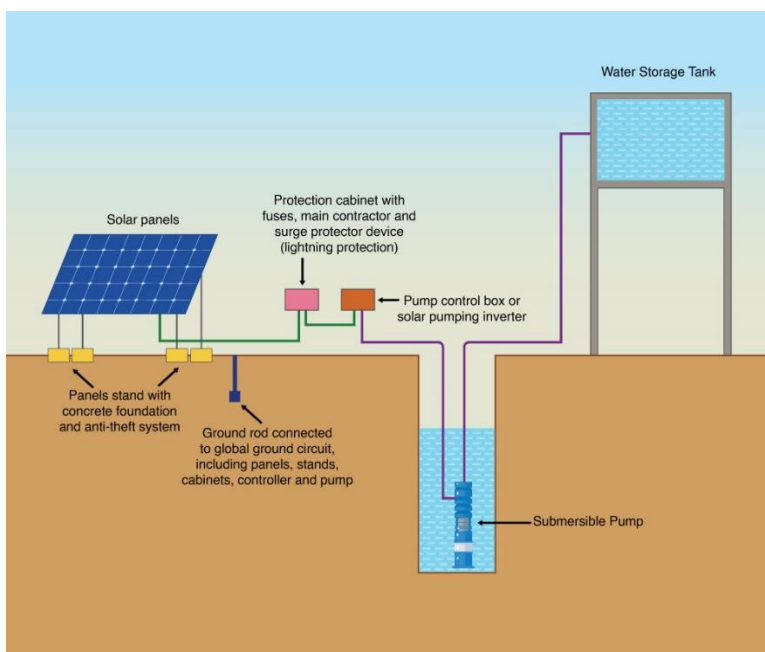
- Always wear gloves or eye masks if you are working with any rough or sharp knife or object. Eye masks are important while working with chemical substances or soldering.
- Wear steel boots to cover your feet completely, while carrying heavy equipment.
- While maintenance of the pump, inverters, etc., always switch off the main power source. Do not touch the metal turner with your hands or finger in the running pump, it will cause injury.

- Lift any item with proper technique. Bend in squat at your hips to the ground and keep your back and legs straight while lifting.
- Use a pulley and proper lifting equipment to carry heavy instruments from one place to other or from ground to height.
- Wear lumbar belts while operation. Get help from a co-worker in such cases.
- Wear safety belts while installing solar systems on the roof or at heights.

## CONSTRUCTION OF THE FOUNDATION FOR THE SOLAR WATER PUMP UNIT:

The following steps will be taken as the SWP system installation:

**STEP 1.** The line diagram (layout) of the SWP system will be prepared.



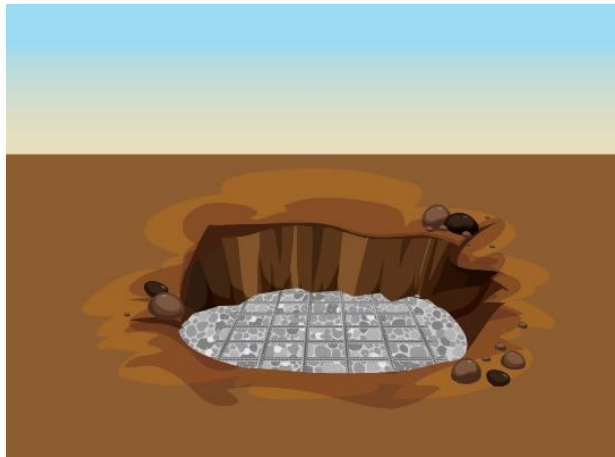
1. Solar panels.
2. Panels stand with concrete foundation and anti-theft system
3. Protection cabinet with fuses, main contractor and surge protector device (lightning protection).
4. Pump control box or solar pumping inverter.
5. Ground rod connected to global ground circuit, including panels, stands, cabinets, controller and pump.
6. Submersible pump

**Fig.1.12:** Line diagram (layout) of the SWP system

### STEP 2. Beam/pole placement & foundation:

Pole mounting is the mounting where PV arrays are mounted above a certain height on the ground using poles. In areas with a space limit, pole mounting is preferred. Same as ground mounting, this type of mounting also is easy to maintain and adjust the tilt when required and the space below allows the system.

First of all, we select the module mounting system for beam /pole installation, Now dig a hole, and fill it with gravel. Dig a hole with a diameter of 600-700mm, and a depth of 1200-1500mm. Cover with 70mm thickness gravel. Vertically place the A Pole into, cover it with slurry, and control the perpendicularity of the pole as per the foundation drawing shown the fig.no.1.13



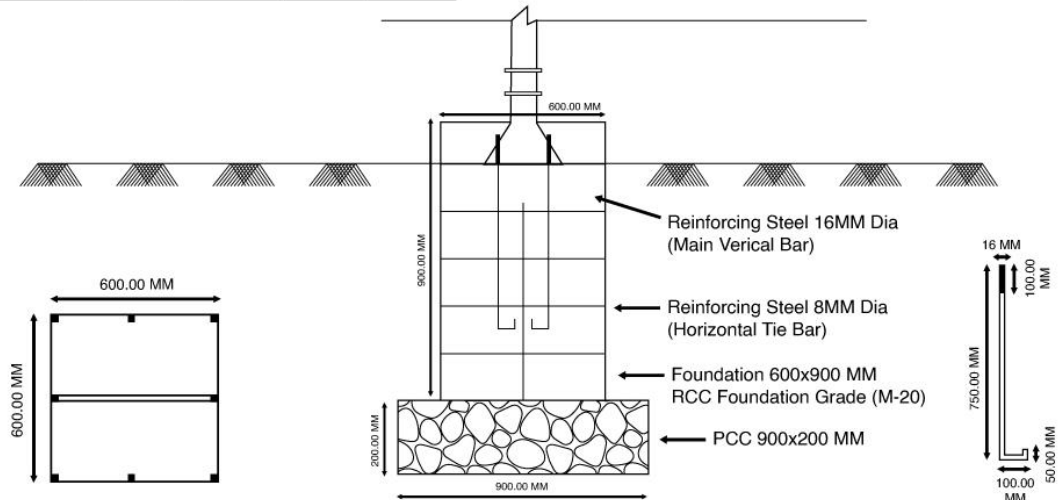
SQ hole and gravel process

**Fig.1.13:** Foundation work

Pole mounting is the mounting where PV arrays are mounted above a certain height on the ground using poles. In areas with a space limit, pole mounting is preferred. Same as ground mounting, this type of mounting also is easy to maintain and adjust the tilt when required and the space below allows the system to cool down by itself.

BOM				
TMT Bar	Length	Weight	Quantity	Total Weight
16 MM	1000 MM	1.578 KG	8 Pcs	12.6 KG
8 MM	2400 MM	0.950 KG	4 Pcs	3.8 KG
8 MM	1250 MM	0.500 KG	4 Pcs	2 KG

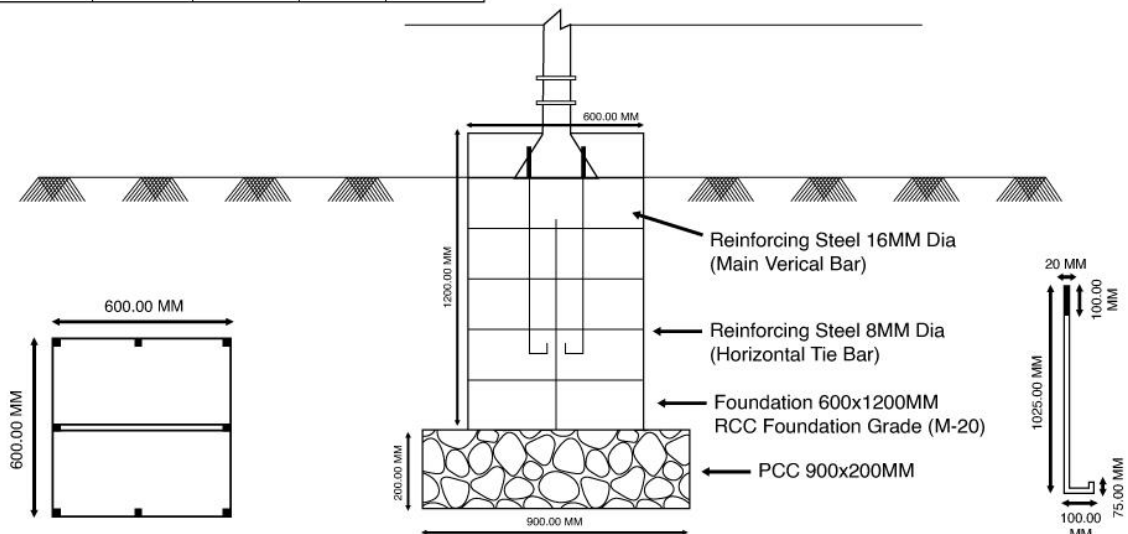
BOM				
Block	Weight	Length	Height	Volume
RCC Column	0.600 MM	0.600 MM	0.900 MM	0.324 CU.M
PCC	0.900 MM	0.900 MM	0.200 MM	0.162 CU.M



**Fig.1.14:** Foundation Design for 4/6 MMS (Module Mounting System)

BOM				
TMT Bar	Length	Weight	Quantity	Total Weight
16 MM	1300 MM	2.05 KG	8 Pcs	16.4 KG
8 MM	2400 MM	0.950 KG	6 Pcs	5.7 KG
8 MM	1250 MM	0.500 KG	6 Pcs	3 KG

BOM				
Block	Weight	Length	Height	Volume
RCC Column	0.600 M	0.600 M	1.20 MM	0.432 CU.M
PCC	0.900 M	0.900 M	0.200 MM	0.162 CU.M



**Fig.1.15:** Foundation Design for 8 MMS (Module Mounting System)

Mounting refers to the process of installation or setting up of PV modules on pre-prepared mounting structures on the ground or the roof. Each PV array requires a mounting structure to stand on the ground or the roof. Mounting elements include:

- Poles to be installed directly in the ground or embedded in the concrete structure depending on the type of soil
- Mounting structure on which PV modules are fitted
- Steel or concrete base to hold the system

Ground mounting structures can be fixed or can have an adjustable tilt to support the season variants. Technicians have to make decisions and select the type of mounting to be done as per the site conditions.

### **STEP 3. Set up the Solar panel stand & Solar array Rack**

The solar array rack is the metal frame on which solar modules will rest. The factory-built mounts have to be assembled as per the company guidelines with bolts and make one solid structure. This structure will be attached to the pole mounted on the ground. Make sure the structure is attached firmly. Place the array at some height above the ground to avoid shading from any nearby vegetation or unnecessary rodents. Keep in mind that trees and perennial plants will grow taller over the years. If the mounting area is accessible to livestock and other human beings, it is advisable to keep the height much higher.

The Solar panel is a metal framework consisting of I-beams/ circular beams and C-channel that help support the Solar panel and keep them inclined at the required angle. In the next couple of steps, but before start building the metal stand or framework, one must determine the optimum angle at which one must place solar panels to get the maximum efficiency from the solar system. To get the best out of photovoltaic panels, you need to angle them towards the sun. The optimum angle varies throughout the year, depending on the seasons and your location and this calculator shows the difference in sun height on a month-by-month basis.



**Fig.1.16:** Placing Solar rack

**Solar Array /placing the solar modules on the rack/ Adding solar panels**

The solar array consists of parallel and series combinations of identical photovoltaic (PV) modules to form the required capacity (kW) to drive the motor and pump. The number of modules in a series generates the required voltage suitable to supply power to the controller and the number of modules in parallel generates the required current. Thus, the series and parallel combination of the modules generate the required voltage and current, respectively, to drive the motor and pump. Figure no. 1.17 shows a solar array.



**Fig.1.17:** Solar Panel mounting

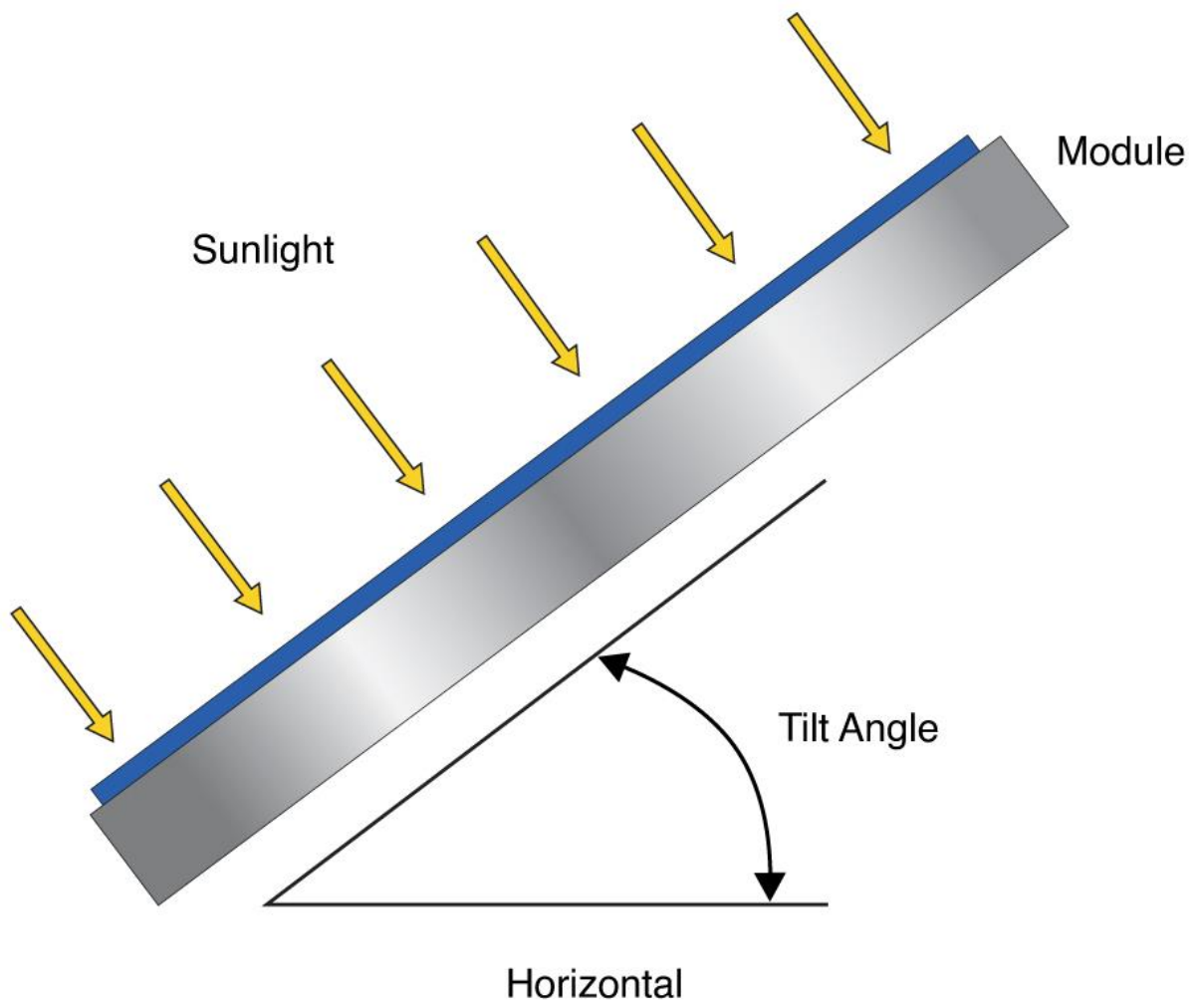
First, determine the position where the array needs to be installed. The solar PV array is to be installed carefully at a proper location to avoid shadowing any part of the array or other obstructions throughout the day at any time of the year.

The output from the solar array is maximum when solar radiation falls perpendicular to the surface of the module.

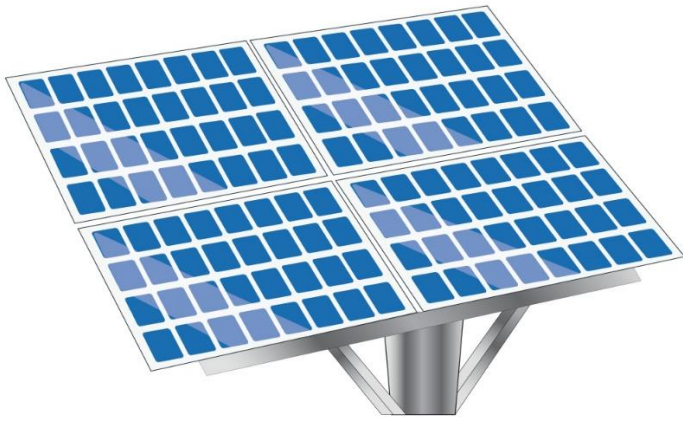
A Solar panel does the work of supporting the pump and consists of I beams and C Channels. Before you start building this metal framework, you must find out the appropriate solar angle. The solar angle is the optimum angle at which the panels or pump will receive the maximum sunlight. Angle the panels towards the sun and to find it you can use an online calculator.

**Tilt angle:** A tilted array will receive more light than a vertical array. Any angle between vertical and  $15^{\circ}$  off horizontal can be used. For self-cleansing, a minimum tilt of  $15^{\circ}$  to the horizontal is recommended to allow the rain to wash the dust off the solar panels. For a south-facing panel, the recommended tilt angle is between  $15^{\circ}$  to  $60^{\circ}$ . The solar module has to be installed at a tilt angle approximately equal to the latitude of the area. The optimum tilt angle is calculated by adding 15 degrees to your latitude during winter and subtracting 15 degrees from your latitude during summer. For instance, if the latitude is  $34^{\circ}$ , the optimum tilt angle for solar panels during winter will be  $34^{\circ} + 15^{\circ} = 49^{\circ}$ . The summer optimum tilt angle on the other hand will be  $34^{\circ} - 15^{\circ} = 19^{\circ}$ .





**Fig.1.18:** Tilt angle



(a) 4-Module-MMS20.



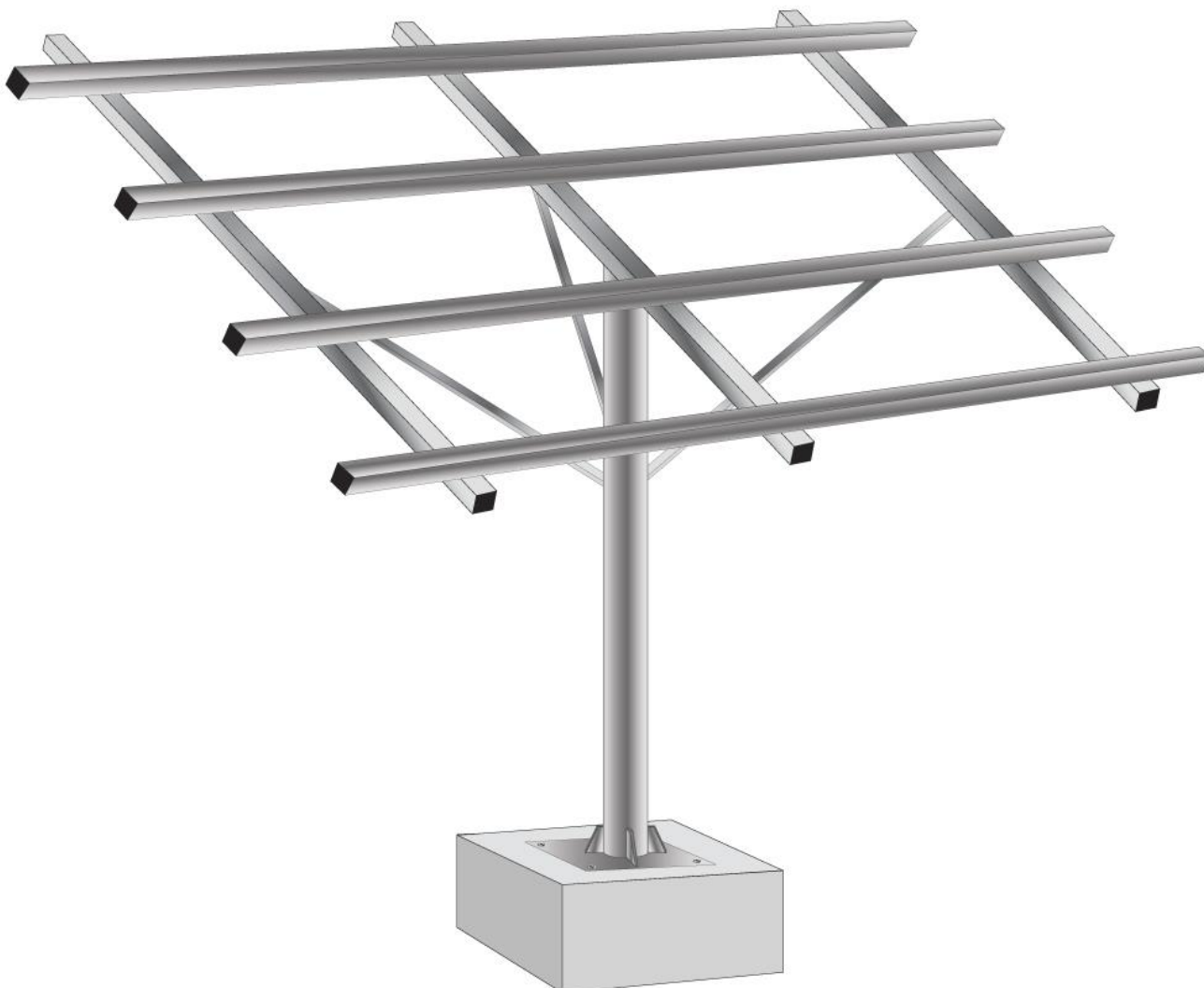
(b) 6-Module-MMS



(c) 8-Module-MMS



(d) Side-View



(e) MMS for solar water pumping system

**Fig.1.19: (a),(b),(c),(d),(e)** Different types of module mounting structures

Standard MMS for 4, 6, and 8 solar modules has been specified. These standard MMS may be used in combinations for different capacities of solar water pumping systems as follows:

1. Standard MMS of 4 Modules for 1 HP
2. Standard MMS of 6 Modules for 2 HP
3. Combination of standard MMS of 4 Modules and 6 Modules for 3 HP
4. Combination of two standard MMS of 8 Modules for 5 HP
5. Combination of three standard MMS of 8 Modules for 7.5 HP and so on

### STEP 3. Make the electrical connections

Place all PV modules/panels on the rack and do connections of wire with the help of the MC4 PV connector. MC4 connectors are used to connect solar panels. These are universal connectors and can be connected to any type of solar panel. The solar array wiring becomes simpler and faster using MC4 connectors.



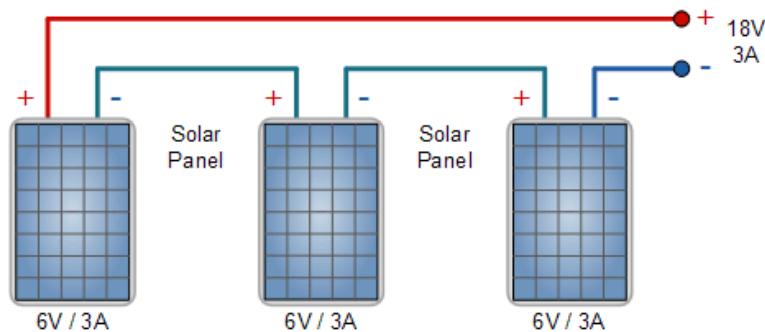
**Fig.1.20:** MC4 connection

### Solar panel wiring

PV solar panels can be wired together in series, in parallel, or in a combination of series and parallel to obtain the needed output voltage and current.

PV panel wiring generally has two types:

1. **PV panels are wired in series** by connecting the negative terminal of one panel to the positive terminal of the next panel as shown in figure no. 1.21 When panels are wired in series, the panel voltages are added.

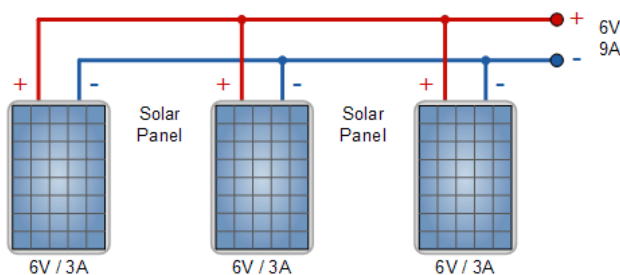


**Fig.1.21:** PV panels are wired in series

In this method, all the solar panels are of the same type and power rating. The total voltage output becomes the sum of the voltage output of each panel. Using the same three 6 volts, 3.0-amp panels from above, we can see that when these PV panels are connected in series, the array will produce an output voltage of 18 Volts ( $6 + 6 + 6$ ) at 3.0 Amperes, giving 54 Watts (volts \* amps) at full sun.

### **PV panels are wired in parallel**

Connecting solar panels in parallel is used to boost the total system current and is the reverse of the series connection. For parallel connected solar panels you connect all the positive terminals (positive to positive) and all of the negative terminals (negative to negative) until you are left with a single positive and negative connection to attach to your regulator.

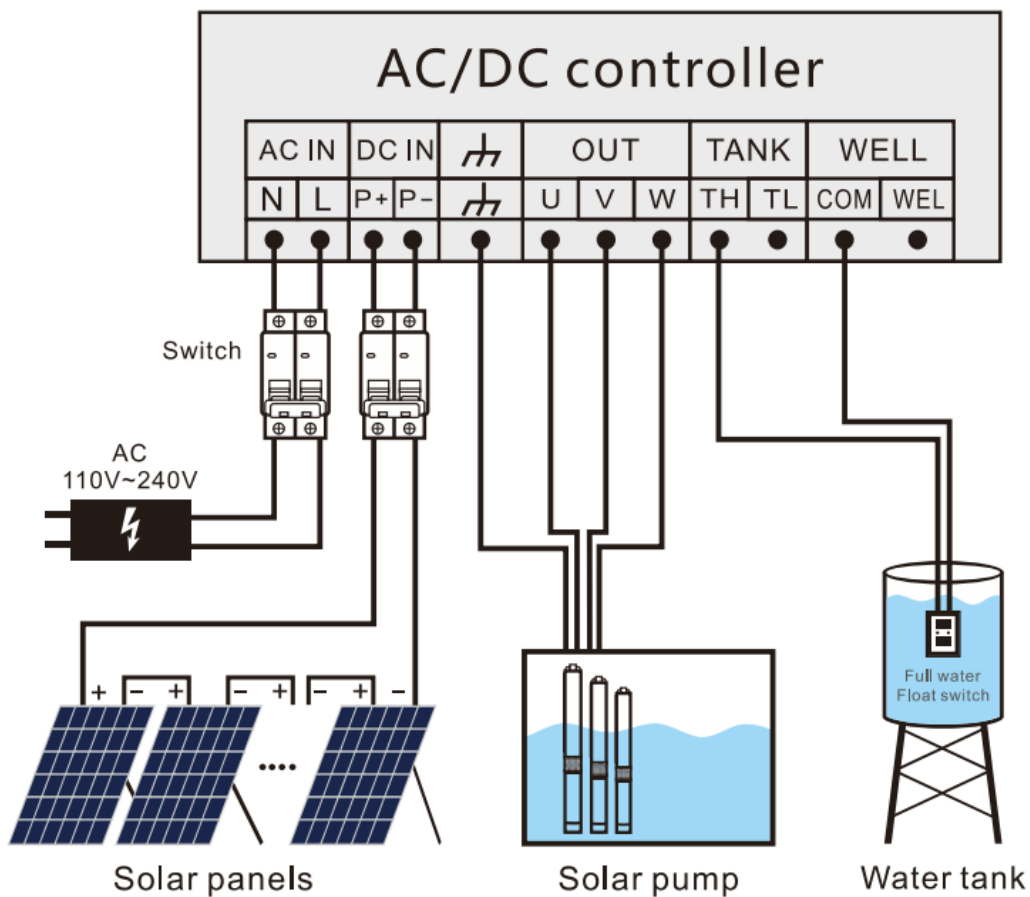


**Fig.1.22:** PV panels are wired in series

All the solar panels are of the same type and power rating. Using the same three 6 volt, 3.0 Amp panels as above, the total output of the panels, when connected together in parallel, the output voltage remains at the same value of 6 volts, but the total amperage has now increased to 9.0 Amperes ( $3 + 3 + 3$ ), producing 54 watts at full sun.

### **Controller Installation:**

The controller is another major component of the solar PV water pumping system. As already explained in the earlier section, the controller takes DC inputs from the solar PV array and supplies pulsating DC or variable frequency AC to the motor.



**Fig.1.23:** Typical circuit diagram of AC/DC controller

Pump care should be taken that the MPPT (Maximum power point tracking) range of the controller and the array output voltage match properly. It is always advised to keep the controller box closer to the array to avoid cable losses. The number of panels in series and parallel should be selected suitable to the MPPT inputs of the controller.

Also, ensure that the motor & pump and the controller output are compatible.



**Fig.1.24:** Controller Box

In view of the high DC voltages available in the controller, ensure proper Grounding. It is also advised that the farmers should not open the controller box for purpose of repair to avoid high voltage DC shocks.

### **STEP 3. Installation of Submersible Pump**

#### **I. Topping up the motor.**

The submersible motor is supplied pre-filled with a mixture of clear cold drinking water and anti-corrosive liquid. The following steps are executed before installation:

- a) Position the motor vertically on its base.
- b) Check if all fasteners are tight. Tighten if required.
- c) The two threaded plugs provided at the top/circumference of the cable box are removed

#### **II. Waterproofing the submersible motor cable - supply cable joint**

Submersible Motors are supplied with a 3-core PVC insulated flat cable of length 3 meters.

The free end of the 3-core cable of the motor needs to be connected to the supply cable from the control panel.

As this joint is always nearly submerged in water, the joint needs to be waterproof.



### III Checking the direction of rotation of the motor

After waterproofing the joint connecting the submersible motor cable and supply cable, check if the direction of rotation of the motor shaft matches the direction marked on the visible cable box top face.

The direction of rotation is counter-clockwise when viewed from the motor shaft end as marked on the cable box.

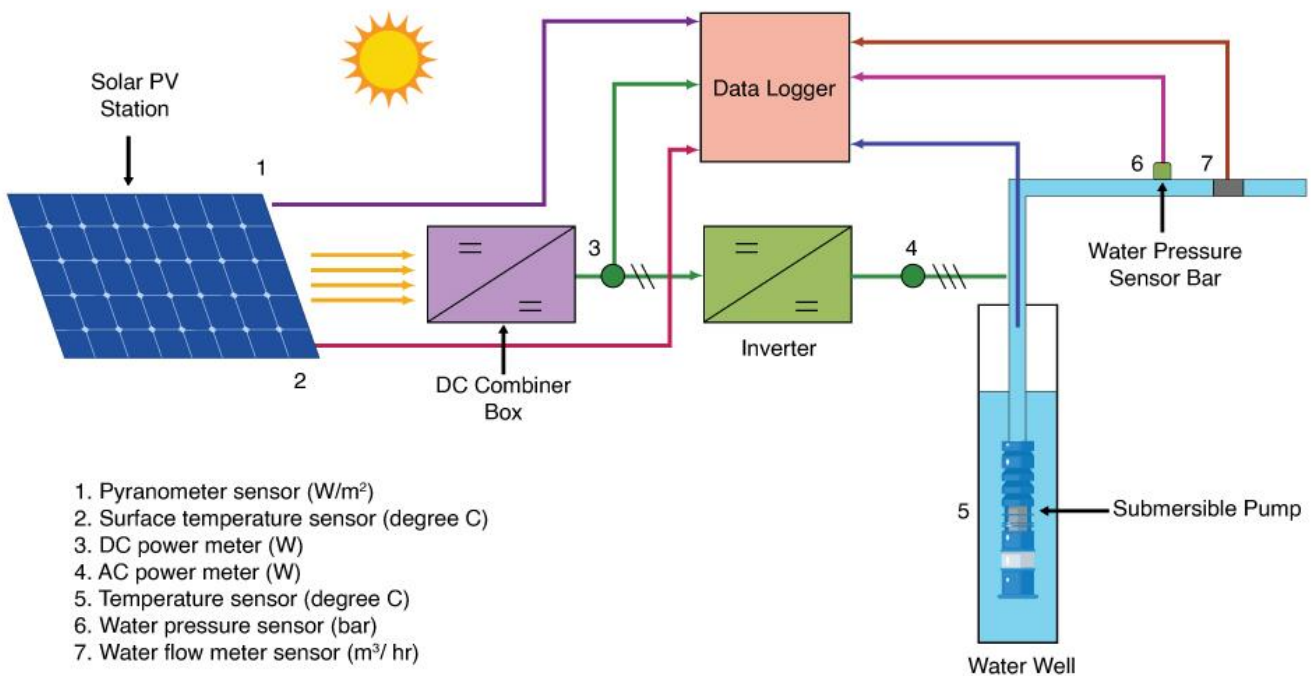
Connect the free ends of the cable to the control panel and energize the motor for a second or two.

For added protection, continuously pour clean water over the sand guard to remove heat generated.

Check the direction of rotation of the motor shaft.

If the direction of rotation is in the same direction as that marked on the cable box face, the connections are correct.

In case the direction of rotation of the motor shaft does not match the marking on the cable box in the three-phase motor, interchange any two lead wires at the control panel and confirm as before.



**Fig.1.25:** SWPS with monitoring system



## SESSION 04

### Practical Exercise

1. What are the parameters of selection and design of the solar water pumping system.
2. Draw the Flow chart of the Design and installation process of the solar water pumping system
3. Explain with the help of Total dynamic head with the help of a line diagram.

### Check Your Progress

#### A. Short Answer Question

1. Which direction is the face of solar module mount in India?
2. Why do we tilt solar panels?
3. What is parallel wiring?
4. Write all the steps of SWP system installation.

#### B. Fill in the blank

1. .... are used to connect solar panels.
2. **Setting the solar module at the ..... increases the power output**
3. **The ..... takes DC inputs from the solar PV array and supplies pulsating DC or variable frequency AC to the motor.**

**Answer.1. MC4 connectors 2. optimum tilt angle 3. controller**

#### C. Multiple choices Question

1. The series connection of PV module is used for
  - a) Increasing the voltage
  - b) Decreasing voltage
  - c) Increasing voltage and current remain same
  - d) Increasing current
2. The parallel connection of PV module is used for
  - a) Increasing the voltage
  - b) Decreasing voltage
  - c) Increasing voltage and current
  - d) Current increasing and voltage remain same
3. Which direction is best for solar power/ radiation in India?
  - a) East

- b) North-west
- c) South east
- d) South

**4. The series connection of PV module is used for**

- a) Increasing the voltage
- b) Decreasing voltage
- c) Increasing voltage and current remain same
- d) Increasing current

**5. Which factors that affect the output of Solar Power System:**

- a) Tilt angle
- b) Cleanliness of Solar Panel Surface
- c) Weather Change
- d) all of the above

**ANSWER**

- c) Increasing voltage and current remain same **2.** c) Current increasing and voltage remain same **3.** d) South **4.** d) all of the above

<b>Module 2</b>	<b>Repair and Maintenance of Solar Pump</b>
<b>Module Overview</b>	
This module provides essential knowledge and skills for maintaining Solar Water Pumping System, focusing on the procedures for cleaning, testing, and inspecting solar panels. Students will learn how to ensure the optimal performance and longevity of solar pump installations through regular maintenance and fault detection.	
<b>Learning Outcomes</b>	
<ul style="list-style-type: none"> <li>• Describe the procedure of cleaning and testing solar panel</li> <li>• Checking of solar panel mounting systems and identifying the different faults in the solar PV system</li> </ul>	
<b>Module Structure</b>	
Session 01: Cleaning and testing of solar panel	
Session 02: Checking and identifying the different faults in the solar pumping system	

### **SESSION 1: CLEANING AND TESTING OF SOLAR PANEL MAINTENANCE**

Solar Photovoltaic panel cleaning technology can considerably increase the efficiency of electricity generated and also increase the durability of Solar panels. The various cleaning methods, such as electrostatic cleaning systems, super hyperbolic coating methods, mechanical methods, microcontroller-based automatic cleaning methods, self-cleaning nanodomies, and various characteristics of dust particles are discussed in this session. This unit throws light on various cleaning methods for solar photovoltaic panels and maintenance of solar water pumping system Before we clean the solar panel will follow the below instructions –

- Never use an abrasive sponge or soap for your solar panel cleaning as may scratch the glass. The best way to clean solar panels is by using a soft rag or biodegradable soap.
- It is important not to use harsh materials when cleaning solar panels as they

could cause damage, and solar panels are costly to repair.

- For your safety and the safety of others around you, use a long-handled wiper to clean the panels while you are standing on the ground.
- If you must get on the roof, take proper care as once you begin cleaning, the roof becomes slippery and you could slide off when you get down, so use safety ropes or a harness for support.
- Always watch out for dirt on the solar panels to make sure it doesn't build up since they can absorb sunlight better when they are free of dirt.

A few methods of cleaning solar panels discuss below.

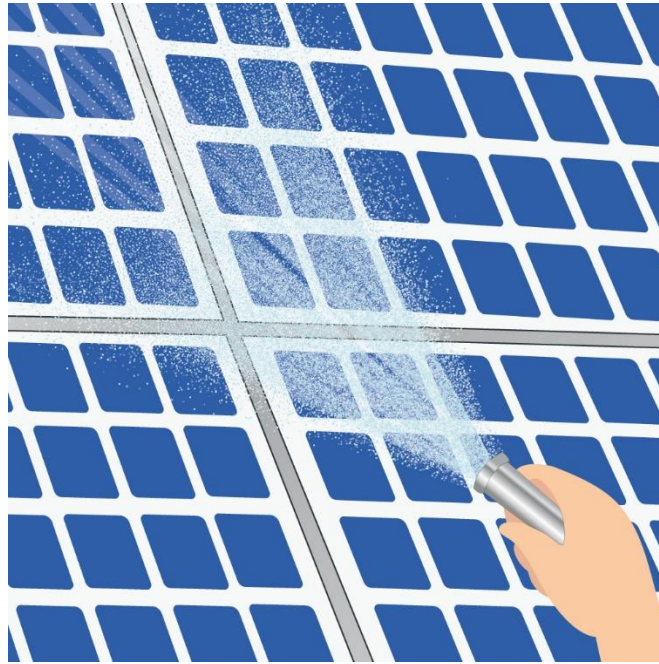
**1. Clean Solar Panels surfaces with a soft brush or a sponge:** In this method, use a foam base brush or a sponge. Generally soft brush use needs to clean 10-20 solar PV panels it is the simplest way to clean the panel.



**Fig. 2.1:** Clean Solar Panels surfaces with a Soft Brush or a Sponge

## **2. Cleaning with Power washing:**

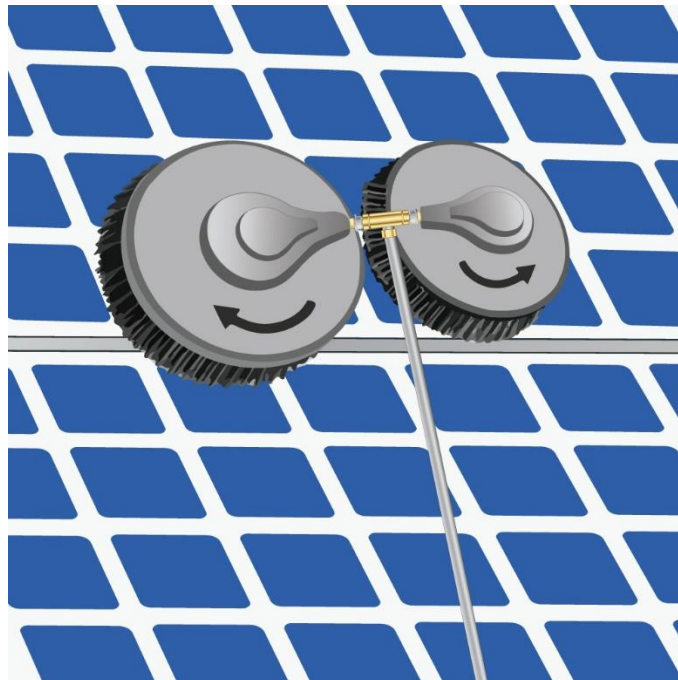
High-pressure water flushing is the process of cleaning a solar panel by spraying it with water from a nozzle. Power washing with plain water is the best method because it is quick and effective, but it is risky. The glass/metal seal on the front of the modules cannot withstand the potential force from power washing, and forcing water into the module will almost certainly destroy it and void the warranty. However, believe that with caution, power washing can be effective. When the modules are hot, do not spray them with water. The glass may break, and even if it does not, you may cause damage to the metal/glass.



**Fig.2.2:** Cleaning with Power washing

**3. Photovoltaic cleaning machines powered by electricity (semi-automatic):**

This technology used small and medium-sized solar panel arrays. It is easy operation and has high-cost performance. A typical diagram is shown below in fig. 2.3

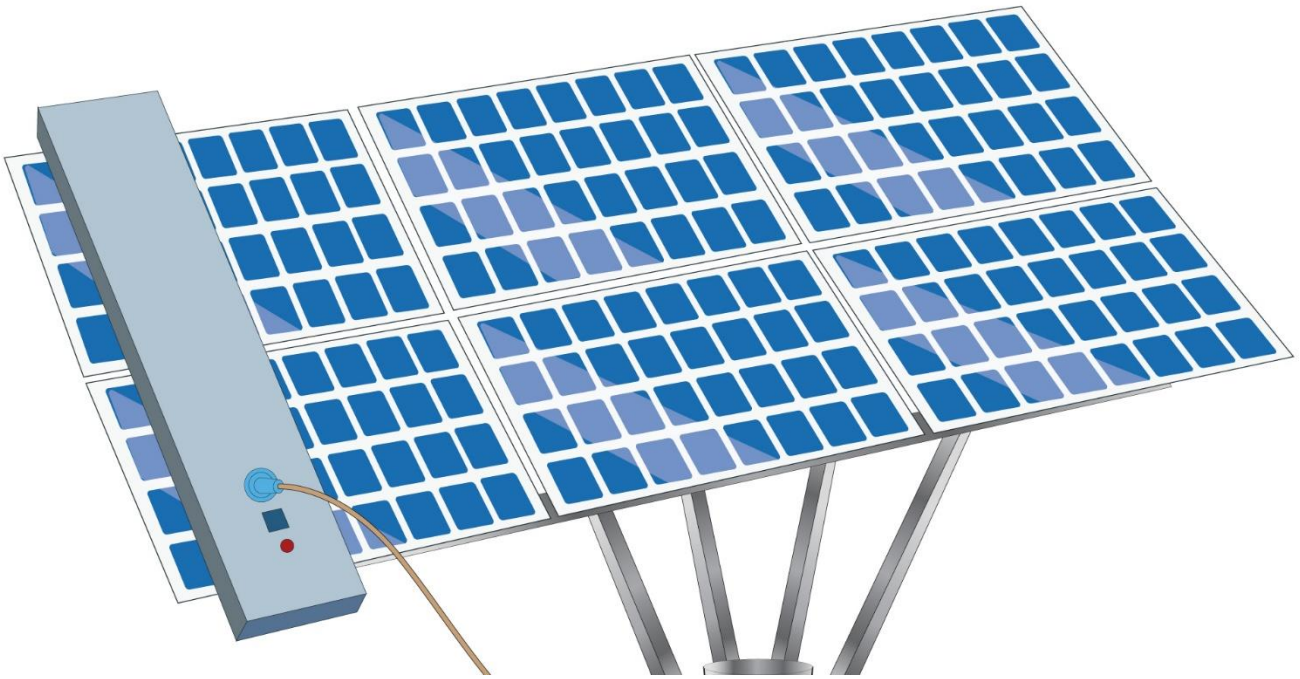


**Fig. 2.3:** cleaning machines powered by electricity

**4. Automatic cleaning:**

Technology now allows the automatic cleaning of solar panels without the use of water or labour. The system takes advantage of the fact that most dust particles have an electric charge, which is especially useful in dry environments. The entire panel vibrates to shake

dust loose.



**Fig. 2.4:** Automatic cleaning:

**TESTING OF SOLAR PANEL:** Solar panel testing is key to assuring both the quality and safety of a module. Solar panels have a long lifespan: properly built and installed equipment should generate usable electricity for more than 25 years. Given the longevity of your investment, you want to make sure that any equipment on your roof will perform well and operate safely on your roof.

The power rating of a solar panel is given by the manufacturer and the number simply represents the amount of power that the solar panel is capable of producing under the most ideal conditions. However, in reality, solar panels are rarely exposed to ideal conditions for more than a few hours per day.



Essentially, testing your solar panels will allow you to make sure that they are generating enough power to meet your needs and let you know if you need to reinstall them so you can optimize their performance and get the highest possible amount of solar electricity out of your system.

Now can measure the following term of solar panel with the help of a multimeter-





- Open circuit voltage ( $V_{oc}$ )
- Short circuit current ( $I_{sc}$ )
- Operating current

We can use the following steps for testing solar panel






Model : NPA 100S- 12H-SQ		
Max Power	Pmax	100w
Operating Voltage	Vmp	16.77V
Operating Current	Imp	6.26A
Open Circuit Voltage	Voc	19.83V
Short Circuit Current	Isc	6.56A
All rating at STC 1000W/m <sup>2</sup> . AM 1.5 spectrum. 25°C		
 <b>Warning Electrical Hazard</b>		
<p>This solar module produces electricity when exposed to light. Cover all modules in the PV array with opaque material before making any wiring connections or operating the terminal box.</p>		

(1)

Module Type	ESP-310
Rated Maximum Power (Pmax)	310W
Power Tolerance	0-5W
Current at Pmax (Imp)	8.38A
Voltage at Pmax (Vmp)	37.0V
Short-Circuit Current (Isc)	9.01A
Short-Circuit Voltage (Voc)	45.5V
Nominal Operating Cell Temp (NOCT)	45±2°C
Weight	23.0ZKG
Dimension	1956*992*45mm
Maximum System Voltage	1000V
maximum Series Fuse Rating	15a
Cell Technology	Poly-si
All technical data are measured at STC 1000W/m <sup>2</sup> , 25°C AM 1.5	
   	
Module Application Class A	

(2)

Module Name	CHSM6612P-300
Maximum Power	300.0Wp
Open Circuit Voltage (Voc)	45.16V
Short Circuit Current (Isc)	8.91A
Voltage at Pmax (Vmp)	35.74V
Current at Pmax (Imp)	8.40A
Fuse Rating	15A
Maximum System Voltage	DC1000V
Power Tolerance	D~+5W
Nominal Operating Cell Temp (NOCT)	46°C
Cell Technology	Poly-si
Module Application: Class A	Module Safety Class II
All technical data are measured at STC 1000W/m2, 25°C AM 1.5	
<p>Warning:  This solar module produces electricity when exposed to light.  One module on its own is below the safety extra low volt level,  but multiple modules connected in series (summing the voltage)  or in parallel (summing the current) represents a danger.</p>	
Company Name: ABCDEFGH Address- XXX-XXXX-XXXXX Tel: +86-576-5306316666666 Fax: +86-576-530631666666	  

(3)

**Fig.2.5:** 1,2,3 A typical solar panel specification

- **Open circuit voltage (Voc):** When the maximum load is connected to a PV device (resistance = infinite), a PV device produces maximum voltage and zero current, referred to as its open-circuit voltage, Voc.

Locate the open-circuit voltage (Voc) on the specs label (as per the fig no.2.3) on the back of your solar panel. Remember this number for later.

For this example, I'm using the New power100W 12V panel. It has a Voc of 19.83V. Prep your multimeter to measure DC volts. To do so, plug the black probe into the COM terminal (common terminal) on your multimeter. Plug the red probe into the voltage terminal. Set your multimeter to the DC voltage setting (and the correct voltage range if yours isn't auto-ranging). It is indicated by a solid line above a dotted line next to the letter V. Locate the positive and negative solar panel cables. The positive cable is typically the one with the male MC4 connector, which has a red band around it. Touch the red probe of your multimeter to the metal pin inside the positive MC4 connector. Touch the black probe to the metal pin inside the negative MC4 connector. Read the voltage on your multimeter and compare it to the open circuit voltage (Voc) listed on the back of panel. (If voltage reading is negative, reverse the probes and measure again.) measured a  $V_{oc}$  of **19.85V** on panel. The claimed  $V_{oc}$  for this panel is 19.83V, so were spot on. The voltage measure with multimeter should be close to the open circuit voltage listed on the back of the panel. It doesn't have to be identical,



though.

- **Short circuit current ( $I_{sc}$ ):** When zero load is connected to a PV device (resistance = zero), the device produces maximum current and zero voltage, referred to as its short-circuited current ( $I_{sc}$ ).

Locate the short circuit current ( $I_{sc}$ ) on the specs label on the back of the panel.

Remember this number for later. panel's  $I_{sc}$  is **6.56A**.

Prepare your multimeter to measure amps. To do so, move the red probe to the amperage terminal. Set multimeter to the amp setting (A), choosing the right limit if yours isn't auto-ranging. The short circuit current you're measuring should be close to the one listed on the back of the panel. We measure 6.53A. it is similar to the  $I_{sc}$  listed on the back of the panel, panel is working fine.

- **Operating current:** When different load connected to a PV device (varying resistance) to measure the current, can use a multimeter. Again, these devices are affordable and worth investing, if you are running a solar power system. They can also be found at most hardware and automotive stores. If want to make sure are getting an accurate reading; you will also need to use a variable resistor box. These devices allow you to get readings at different levels of resistance.

Once you have the appropriate tools, you can use the multimeter to test your solar panels by following these steps:

- ✓ Locate the junction box (protected enclosure for electrical wiring)/converter box, which is usually located at the back of the solar panel. If it has a cover, remove it.
- ✓ Locate the positive and negative connectors and make sure are certain you know the difference. Consult the instruction manual for your solar panel if they are not clearly marked, or if you are unsure that you have correctly identified them.
- ✓ Make sure solar panel is receiving the same amount of sunlight that it normally would.
- ✓ Set the multimeter to read DC power (DC Voltage and DC current respectively). Also set the multimeter to measure a voltage level that is suitable for solar panel, meaning will want to set it higher than the voltage rating the solar panel has. This will make sure can get an accurate rating and the multimeter itself is not interfering.
- ✓ Connect the multimeter to the solar panel correctly, meaning the positive and negative clips of the multimeter are connected to the correct connectors.
- ✓ Note the voltage reading. Once you have your reading, turn the multimeter off, then you can disconnect the device from your solar panel.
- ✓ Following the steps above should give an accurate reading of the solar panel voltage. If are testing a fairly new solar panel in conditions where it is receiving adequate

sunlight, the voltage should be fairly similar to the voltage rating the solar panel had when panel is in good working condition.

## Maintenance of solar water pumping system

### Routine maintenance

Once the solar pumping scheme has been installed and commissioned, several simple actions are to be followed by the owners of the system to prevent failure of the water supply due to an unexpected system shutdown. Routine maintenance activity is similar to the daily tasks that need to perform while operating the solar water pumping system. Inspection is required day to day or during the week to check that all components are working and damage-free.

Follow the below chart for schedule maintenance:

**Table No.2.1 Routine Maintenance for SWPS (solar power pumping system)**

<b>INSTRUMENTS</b>	<b>ACTIVITY</b>	<b>TIME</b>
Solar panel	Cleaning	Weekly and monthly/when dirty
	Trimming trees	If needed to avoid shadow
MMS	tightening of clamps and nuts and bolts	If needed
Controller /VFD	Reading	Once a month
Piping system	Inspect water piping, repair	Fortnightly
Pump	Recording pumping hour	Daily
	Check noise and discharge	Once a month or when not working
Wiring	Fault of wiring	Once a quarter
		Once a year

**Preventive maintenance:** A fundamental element of maintenance services, preventive maintenance involves regular visual and physical inspections as well as verification activities to comply with the operating manuals. The preventive maintenance plan

details a list of inspections that should be performed at predetermined intervals (typically quarterly, biannually, or annually) by a technician with specialized knowledge. Tracking records of preventive maintenance carried out will optimize activities further. The maintenance contract should include this scope of services and each task frequency. Ideally, such a contract will be negotiated together with the installation contract. It is the responsibility of the contractor in charge of maintenance to prepare the preventive maintenance plan for the duration of the contract period.

## SESSION 1

### Check Your Progress

#### A. Short Answer Question

1. Explain the importance of maintenance.
2. What is the Open circuit voltage?
3. Which parameter of the solar panel is measured by a multimeter?
4. Discuss the various cleaning methods of solar panels.
5. What do you mean by short circuit current?

#### B. Fill in the blank

1. A digital multimeter is used for .....
2. Unit of current is .....
3. Junction box is .....
4. .... setting should be used to test a fuse.

**Answer. 1. voltage, current, and resistance 2. Amperes 3. protected enclosure for electrical wiring. 4. Continuity**

### C. Multiple Choice Question

1. Identify this tool



- a) Pyranometer
  - b) Multimeter
  - c) Ammeter
  - d) Voltmeter
2. The “ $\Omega$ ” symbol is used for
- a) Current
  - b) ohm
  - c) Voltage
  - d) AC Current
3. When zero load is connected to a PV device means
- a) zero Current
  - b) zero resistance
  - c) zero Voltage
  - d) none of the above
4. Which setting should be used to test a fuse?
- a) Continuity
  - b) Voltage
  - c) Current
  - d) hFE (Hybrid parameter forward current gain, common emitter)
5. What does 1 displayed on the left-hand side of the screen show?
- a) 1 A

- b) 1 V
- c) 1 Ohm
- d) Out of Range

**ANSWER**

1. b) Multimeter 2. b) ohm 3. b) zero resistance 4. a) Continuity 5. d) Out of range.

**SESSION 2:**

**CHECKING AND IDENTIFYING THE DIFFERENT FAULTS IN THE SOLAR PUMPING SYSTEM**

Maintenance of equipment regularly is one of the most important aspects of any system whether electrical or mechanical. Maintenance of equipment helps in increasing the efficiency and output capacity of the system. When equipment runs efficiently, the project achieves the desired goal. Maintenance on time also helps you in avoiding unscheduled delays and issues in the system.

Solar water pumping systems like other systems also require regular monitoring and maintenance to ensure that water is pumped regularly and farmers do not suffer due to the untimely breakdown of the system. Solar panels however require very minimal maintenance as compared to other equipment.

The following points describe the importance of maintenance of solar water pumps:

- Increases the shelf life of your equipment by a significant amount.
- Increases the capacity and efficiency of your system.
- Delays the cost of purchasing your next equipment.
- Saves fuel and other resources due to less loss of energy in the well-maintained equipment.
- Some instruments emit hazardous gases and waste when not maintained properly or when they become old.
- Ensures the safety of equipment and from any dangerous incidence.
- Timely fixes the issues like leakages, loss of power, part failure etc.

**Checklist of Maintenance**

**Modules and Arrays**

- Check the conformity of the solar modules/arrays as per the specifications.
- Compare the number of modules in the array with the design specified.
- Check to see if there are any shade problems due to vegetation or new building. If so, make arrangement for removing the vegetation or moving the panels to a shade-

free place.



**Fig 2.6: Shade Problems**

- Check the inclination of the panel as per the season and output.
- Ensure that no module is broken, twisted, scratched, or cleaned. If it is broken (Fig. 2.7) or loose, repair it.



**Fig 2.7: Broken glass of solar panel**

- Measure the voltage output from each string and ensure it's consistent for all the modules.
- To check the performance of the PV module, check the short circuit current
- Check the modules mounted are attached properly and all bolts are intact.
- Ensure the mounting structure is not rusted including bolts.

### **Wiring and cables**

- Ensure all cables are sealed and installed properly.
- Ensure for no broken cables.
- Check that there is no naked cabling and that all cable connections are inside the junction boxes.
- Ensure all cable structures are sufficiently tight and tied with cable ties to the structures.



**Fig 2.23: Cable defect**

- Check the grounding rods for earthing and any kind of damage.
- Cables are not within reach of children or human beings and are above the ground.

### **Solar support structure**

- Ensure that the supporting structure is installed firmly with all bolts.
- Ensure that there is no corroded part in the structure and ensure regular painting of the structure to avoid exposure.
- Check the place around the structure should be clean and easily accessible

### **Inverter/controller/ VFD**

- Check the conformity of inverter specifications.
- Check the inverter is correctly installed and above the ground.
- Make sure that the inverter is well protected from adverse conditions and is placed in a well-ventilated room. Investors should not have open holes to prevent the entry of any insects and rodents.
- Ensure that all devices are protected that are installed in the solar pumping system whether it is a PV array or inverter. Install proper DC connects, breakers, earthing, short circuits, surge protectors, etc.
- Verify inverter supplies current to the load.

### **Steps to follow:**

- Wear the electrical insulation gloves
- Turn off the disconnect switches 1 and 2
- Use a clamp-on ammeter (AC) on the AC side
- Connect the voltmeter (NOT the ammeter) to the battery terminals (remember: Ammeter short circuits the battery and the fuse blows)
- Turn on the disconnect switches 1 and 2
- Observe if voltage and current flowing to the load. If yes, the inverter works properly.

## **Pump**

- Check the conformity of pump and motor specifications.
- Check on the pump setting and connections.
- Check the depth specifications matches with the original.
- Ensure all piping connections are tight and no air pockets are there on joints.
- Ensure the pump settings like the voltage, speed, output, etc.
- Check the performance of the pump in terms of input and output pressure.
- Check the mounting points are firm and steady.
- Inspect the other electrical and mechanical components for seal, insulation
- Inspect the pump for any leakage..
- Inspect the couplings.
- Inspect and clean filters



## **Monitoring The Technical Issues and Repair of The Solar Pump**

### **Troubleshooting**

This provides an overview of the key failures which are often reported in the field. These studies indicate that the batteries failed within 2 years due to improper maintenance, the inverters failed due to poor design and the charge controllers failed the batteries due to improper voltage set points. One of the case studies clearly recommends purchasing only certified products according to quality standards. It is not only important to train the personnel but also important to retain the trained workforce for the sustainability of the programs.

### **Inverter Failure**

- As per one of the research studies, of 90 water pumping systems investigated -22 hardware failures (70% due to inverters) - Poor inverter design.

### **Charge Controller Failure**

Solar home systems (SHS) — most problems were related to charge controller set points

- Quality Standard: Bad quality SHS components were reduced by World Bank Quality Standard in Western China
- Capacity Sustainability: All the staff present during installation training had been transferred to other health centers at the time of the real system installations
- Disconnect between system usage and system design
- Lack of understanding about the limitations of the PV system
- Serious lack of maintenance
- Lack of attention to maintenance priorities
- No maintenance policy
- Lack of local capacity to offer maintenance services recommendations
- Consult and educate end-users on good operational behaviour
- Make maintenance a priority
- Develop, and promote maintenance policies
- Train local technicians and encourage entrepreneurial activity
- Train end-user to perform routine maintenance
- Allocate budgets for maintenance, as well as for training

### **Battery terminal corrosion**

- Further insist on ensuring maintenance in every single installation

### **Common Failures — PV Modules**

- PV module -Low or no power output

#### **Causes**

- Wrong orientation (wrong tilt angle)
- Accumulation of dust
- Crack in the glass lamination
- Shadow
- Climate condition
- Short circuit of bypass diode
- Loose connection of wires
- Theft

#### **Check for the following:**

- Rectify orientation and tilt angle
- Clean PV with water, detergents are not needed
- Tighten loose connections at the terminal box
- Shadowing at PV module between 9 am—3 pm
- Bypass diode

**Table no. 2.1 Troubleshooting points**

<b>S.No</b>	<b>Possible Reason</b>	<b>Check Point</b>	<b>Solution</b>
<b>1.</b>	Loose connection	Terminal	Reconnection/Retightening
<b>2.</b>	The set voltage is shifted	HYD and LYD setting	Rectify setting
<b>3.</b>	Malfunction of C/C	Operation of C/C	If bad, Contact the engineer
<b>4.</b>	Damage to the PV module	Condition of PV module	If bad, replace it
<b>5.</b>	Damage of cable	Condition of cable	Repair/Replacement
<b>6.</b>	Shadow on PV module	Surrounding condition	Removal of the source
<b>7.</b>	Dirt on the PV module	The surface of the PV module	Cleaning

## **Maintaining Log Books:**

Solar pump technicians should maintain the log books of each site installation and maintenance.

Following are the checkpoints that need to be maintained in the log book:

system documentation

- PV system layout and diagram
- Details of the installation date and specifications of each component installed
- Warranty of products
- Record of all the purchases, contracts, and vendor details
- Output parameters of the system
- Connections of the PV system
- Diagram of wiring and earthing being done

Single Line Diagram: This shows the specification of all the electrical flow which is important for maintenance and troubleshooting Regular report of power generation, any issues, and follow-up dates.

## **Maintenance Documentation**

- List of services included in the contract with vendors, installer, and their period of service and rates.
- Monitoring Records: These need to be maintained and watched regularly to ensure the efficiency of the system.
- Contact Information of all stakeholders: Vendors, Installation, Plumber, Electrician, etc.

## **Component Documentation**

- Detailed datasheets of all the components: PV modules, inverters, battery, pump, etc. These will have all the details about your components, their classification, their performance, and their capacity.
- Warranty certificates
- Other certificates like subsidies by the government, safety, insurance, etc.

## SESSION 2

### Practical Exercise

### Check Your Progress

#### A. Short Answer Question

1. Solar panel not generating voltage properly. Write a minimum of three possible reasons.
2. What will happen if the solar panel got damaged?
3. Write the different Troubleshooting points of SWP
4. Write the checkpoints that need to be maintained in the log book.

#### B. True and False

1. VFDs are used to start, stop and control a pump motor throughout its operation.
2. Always check the voltage between any conductor and any other wires, and to the ground. Do not touch the conductive part by a wet hand.
3. VSD (variable speed drive) is compatible with both AC and DC motors.
4. Solar power can be used for running surface pumps and not for submersible pumps.
5. A variable frequency drive (VFD) refers to AC drives only.

**Answer 1) True**

**2) True**

**3) True**

**4) False**

**5) True**

#### C. Match the columns:

##### POSSIBLE REASON

- 1) The PV module not working
- 2) shadow on PV module
- 3) Dirt on the PV module
- 4) Damage of cable

##### SOLUTION

- a) Cleaning
- b) Repair/Replacement
- c) If bad, replace it
- d) Removal of the source

#### ANSWER:

- 1) PV module not working
- 2) shadow on PV module
- 3) Dirt on PV module
- 4) Damage of cable

- c) If bad, replace it
- d) Removal of the source
- a) Cleaning
- b) Repair/Replacement

<b>Module 3</b>	<b>Cost Economics of Solar Pump and Opportunities</b>
<b>Module Overview</b>	
<p>This module explores the financial aspects of Solar Water Pumping System, focusing on cost analysis and the economic factors that influence solar energy projects. It also explores into the business strategies and opportunities in the solar industry, including an overview of government schemes and policies that support solar energy adoption.</p>	
<b>Learning Outcomes</b>	
<ul style="list-style-type: none"> <li>• Calculate the cost of the solar pump and installation cost.</li> <li>• Describe the business strategies, government scheme, and policy</li> <li>• Explain the different marketing strategies- add on, Solar Panel System spare parts</li> <li>• Describe about work effective and annual maintenance</li> </ul>	
<b>Module Structure</b>	
Session 01: Cost Economics	
Session 02: Business Strategies and Government Schemes and Policy	

### **SESSION 1: COST ECONOMICS**

“Solar energy is free, but it’s not cheap” is the major hurdle for the solar industry. There are no technical obstacles peruse to developing solar energy systems, even at the utility mega Watt level however, at such large scales a high initial capital investment is required. Over the past three decades, a significant reduction in the cost of solar products has occurred, without including environmental benefits; yet, solar power is still considered a relatively expensive technology. Industrial society and modern agriculture were founded on fossil fuels (coal, oil, and gas).

The world will make a gradual shift throughout the twenty-first century from burning fuels to technologies that harness clean energy sources such as the sun and wind. As energy demand increases as developing countries modernize and fossil fuel supply constrict, increased fuel prices will force alternatives to be

introduced. The cost of technologically driven approaches to clean energy will continue to fall and become more competitive. Eventually, clean energy technologies will be an inexpensive solution. As the full effect and impact of environmental externalities such as global warming become apparent, society will demand cleaner energy technologies and government policies that favour the development of a clean-energy industrial base. By the end of the twenty-first century, clean-energy sources will dominate the landscape. This will not be an easy or cheap transition for society, but it is necessary and inevitable. Already, solar energy is cost-effective for many urban and rural applications.

Solar water pumping systems are very competitive, with typical paybacks from 5–9 years. We can be achieved this through energy conservation than solar energy usage alone for reducing carbon emissions. The decision to use a solar energy system over conventional technologies depends on the economic, energy security, and environmental benefits expected. Solar energy systems have a relatively high initial cost; however, they do not require fuel and often require little maintenance. Due to these characteristics, the long-term **life cycle costs** of a solar energy system should be understood to determine whether such a system is economically viable. Historically, traditional business entities have always expressed their concerns in terms of economics. An Economical analysis should be looking at life cycle costs, rather than at just the ordinary way of doing business and low initial costs. Life cycle costs refer to all costs over the lifetime of the system. Also, incentives and penalties for energy entities should be accounted for. What each entity wants is to earn subsidies for itself and penalties for its competitors. Penalties come in the form of taxes and fines; incentives may in the form of tax breaks, unaccounted social and environmental costs, and also what the government (society) could pay for research and development.

**Life cycle costs:** Life cycle cost (LCC) is an approach that assesses the total cost of an asset over its life cycle including initial capital costs, maintenance costs, operating costs, and the asset's residual value at the end of its life.

### **CALCULATE THE COST OF SOLAR PUMP INSTALLATION**

The use of energy for the supply of irrigation systems is of great importance for crop production. Even though there are several sources of energy to turn on motors, electric and diesel motors are the most commonly used in irrigation in India

Because of this, the economic analysis of water pumping systems in agriculture is fundamental, because the invested capital is often high and the annual costs may or may not make viable the agricultural activities.

Solar water pumping system costs depend upon the following factor-like PV array, Motor pump set, Voltage Frequency Drive (VFD)/controller, Panel Stand, DCDB, Interface electronics, connecting cables & switches, location, Support structure & tracking system Pipes, etc. now we can calculate the 7.5 hp submersible pump cost. The total cost (before subsidy) for installation and commissioning of the SPV water pump system varies by type, brand, and rating, generally, the installation cost of SWPS is 4.1 lakh to 7 lakhs (without subsidy).

The benchmark costs for Off-grid Solar water pumping Systems for the Year 2020-21. System-wise benchmark costs are:

**Table no.3.1 Capacity-wise benchmark cost of Standalone Solar Water Pumps**

Pump capacity	Type of Pump	Benchmark Cost (Rs. per Pump)	
		General Category States/ union territories of India	North Eastern States/Hill States & union territories of India / Island UTs
0.5HP	AC/DC Surface	53,000	58,300
	AC/DC Submersible	68,000	74,800
1HP	AC/DC Surface	92,400	1,01,700
	AC/DC Submersible	1,03,700	1,14,100
2HP	AC/DC Surface	1,22,200	1,34,600
	AC/DC Submersible	1,31,400	1,44,600



3HP	AC/DC Surface	1,63,200	1,79,700
	AC/DC Submersible	1,68,300	1,85,400
5HP	AC/DC/Surface/Submersible	2,36,500	2,60,500
7.5HP	AC/DC/Surface/Submersible	3,52,500	3,87,750
10 HP	AC/DC/Surface/Submersible	4,45,000	4,45,000

All the above benchmark costs of the system as per MNRE specification inclusive of the total system cost and its installation, commissioning, transportation, insurance, comprehensive maintenance charges for five-year applicable fees and taxes. All the above costs can vary  $\pm 10\%$  to  $12\%$  depending on location, availability, and solar brand.

The cost of a solar water pump has mainly two components (i) fixed cost and (ii) operating cost. The fixed cost includes the capital cost, interest on the capital, and the depreciation of the equipment. The operating cost includes the fuel cost of diesel if a diesel engine is used, and the cost of electricity if an electric motor is used. But in the case of solar water pumps, the fuel cost may be taken as 'nil' since solar energy is freely available. Besides, the operating cost also includes the maintenance cost and the cost of the operator.

While calculating the cost economics, we may work out the annual cost of operation of a solar water pump and then compare it with the diesel pump set cost and the electric motor-driven pump.

### **Cost of operation of water pumps**

Let us calculate the cost of operation of water pumps per day for these cases. The following assumptions are made:

**Table no.3.2** Different parameters used for calculating the payback periods

<b>S.No.</b>	<b>Parameter</b>	<b>Unit</b>	<b>Value</b>
1.	The capacity of the water pump	HP/kW	5.0/3.75
2.	Daily hours of operation	Hour	6.0
3.	Annual operation of water pump	No. of days	150
4.	Price of electricity	Rs. /kWh	6.50
5.	Price of diesel	Rs. / Liter	90.0
6	Working life of the pump set	years	10

7	Discount rate(d)	%	8%
8	The daily wage of the operator	Rs. /Day	300/-
9	The overall efficiency of the diesel engine pump set	%	40
10	The overall efficiency of the electric motor pump set	%	60
11	The overall efficiency of the Solar water pump set	%	
12	Total head of lifting of water	meter	10
13	The capital cost of a 5 HP diesel engine pump set	Rs.	30,000
14	The capital cost of a 5HP electric motor-driven pump set	Rs.	35,000
15	The capital cost of a 5 HP solar water pump	Rs.	2,50,000

Capital Recovery Factor is used to calculate the annualized cost of capital for a discount rate and the lifetime of the system. It is used to work out the lifecycle cost of the system.

$$\begin{aligned}
 \text{Capital Recovery Factor} &= d(1+d)^t / (1+d)^t - 1 \\
 &= 0.08(1+0.08)^{10} / (1+0.08)^{10} - 1 \\
 &= 0.149
 \end{aligned}$$

**(a) 5 HP diesel engine pump set**

Annualised capital cost = 0.149x30000=4520/-  
Annual wage of operator = Rs.150x Rs. 250/- = Rs. 37,500/-  
Annual fuel cost = Rs. 90x 0.75 lts/hr x150x6=Rs. 60750/-  
Total Annual cost = Rs. 1,02,770/-

**(b) 5 HP electric motor pump set**

Annualised capital cost = 0.149x35000=5215/-  
Annual wage of operator = Rs.150x Rs. 250/- = Rs. 37,500/-  
Annual fuel cost :

Input power to motor =  $3.73/0.80= 4.69$  kW

Electricity consumption/cost= $4.69 \times 6.50 \times 6 \times 150=Rs. 27,436/-$

Total annual cost = Rs. 70,151/-

**(c) 5 HP solar water pump set**

Annualised capital cost =  $0.149 \times 2,95,000=43,955/-$

Annual wage of operator = Rs.150x Rs. 250/- = Rs. 37,500/-

Annual fuel cost = Nil

Total Annual cost = 81500/-

From the point of view of the annual cost of operation for the given above parameters, the electric motor is a cheaper option than thereafter solar water pump. The diesel engine pump set is the most expensive option.

**The payback period for the solar water pump**

The cost of diesel saved per year =Rs. 60750/-

The cost of electricity saved per year =Rs. 27,436/-

The payback period vis-à-vis diesel pump set =Rs 2,95,000/Rs. 60750= 4.85  
say 5.0 year

The payback vis-à-vis electric motor pump set =Rs. 295000/Rs. 27,436/-=9.11  
years

## **BUSINESS OPPORTUNITIES:**

The global solar water pump market size was USD 2.38 billion in 2020. The market is projected to grow from USD 2.86 billion in 2021 to USD 5.64 billion in 2028 at a CAGR (Compound annual growth rate) of 10.2% in the 2021-2028 period. The global impact of COVID-19 has been unprecedented and staggering, witnessing a negative impact on demand across all regions amid the pandemic. Based on our analysis, the global market exhibited a decline of -18.1% in 2020 as compared to the average year-on-year growth during 2017-2019. The rise in CAGR is attributable to this market's demand and growth, returning to pre-pandemic levels once the pandemic is over. A solar water pump is a system driven by solar energy and pumps water for many purposes, such as irrigation, community water supply, and potable drinking water, and has decreased its reliance on diesel, gas, or coal. These systems are environmentally sustainable and have low fuel-free maintenance requirements. It is one of the most capable applications of solar energy, which can be effective in rural and remote regions in most of the world. With the rise in demand for reliable and clean water supply and agriculture activities, it is anticipated to increase the product demand in the rural area.

India has great potential for solar energy due to geographical advantages. The nearing equator location of the Indian subcontinent ensures all year guarantee for solar radiation. Starting a solar business in India is a lucrative opportunity for budding Indian entrepreneurs. Solar thermal, photovoltaics can effectively harness the capabilities of solar radiation and conversion into heat and electricity.

Few of the recognized and untapped options are opportunities for the solar energy business in India are listed below-

- **Manufacturing Solar products**
- **Solar Panel Installation work**
- **Solar Project Consultants**
- **Solar cleaning and maintenance services**
- **Distribution of Solar products**
- **Solar energy auditing**

## **Market trend, strategy, and typically available brands of Solar Pump in India**

The solar water pump market is now well-established and mature. There are many manufacturers in the market and below is a list of the top ten solar pump brands

in India. All of these brands' solar pumps are of high quality and efficiency.

- Tata Power Solar Pump
- Shakti Solar Pump
- Falcon Solar Pump
- Amrut Solar Pump
- Crompton Solar Pump
- Lubi Solar Pump
- Waaree Solar Pump
- Texmo Solar Pump
- Oswal Solar Pump
- KBL Solar Pump

The market is fully dependent on the government's policies. Under the PM Kusum scheme, there is ample opportunity for the manufacturers, EPC (Engineering, procurement, and construction) players, and service providers as well. The business opportunities include selling the equipment, consultancy, marketing for the reputed brands, installation and commissioning, post-installation service, training and skill development, etc.

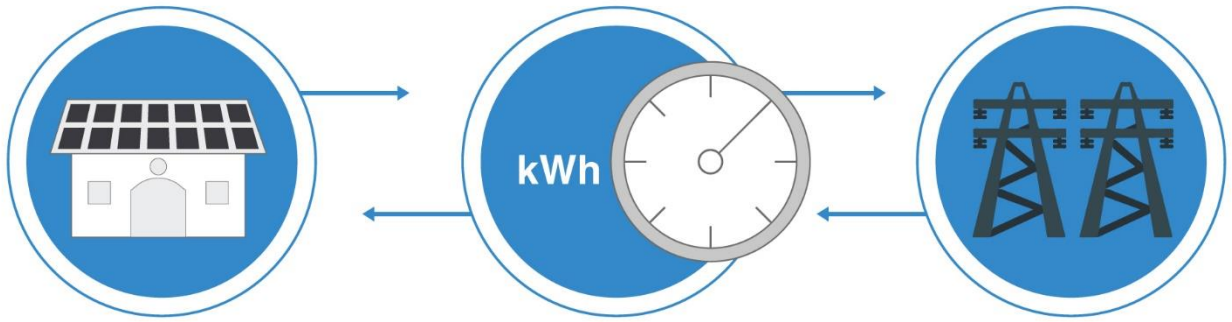
**METERING PROCESS:** An electric meter, or energy meter, is a device that measures the amount of electrical energy consumed by a building, tenant space, or electrically powered appliance. Thus, the process of taking and giving power is called metering.

Electric utilities use electric meters installed at customers' premises to measure electric energy delivered to their customers for billing purposes. They are typically calibrated in billing units, the most common one being the kilowatt hour [kWh]. They are usually read once each billing period.

In the case of a solar system, the metering of electricity is done by two methods

- (i) Gross Metering Method
- (ii) Net Metering Method

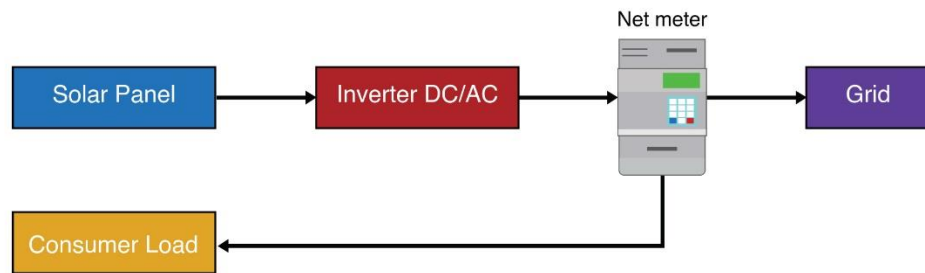
**(i) Gross Metering Method:** In gross metering, the fixed price of electricity produced from a solar system is announced by the distribution companies (DISCOMs), and accordingly, the calculation for the payment is done and the producer is compensated.



**Fig 3.1:** Gross Metering Method

**(ii) Net Metering Method:**

In the net metering method, the units of electricity produced by a solar system are taken into account and are adjusted in the electricity bill at the same tariff as that of the electricity being charged in the bill. This net metering is method is being followed in the grid-connected solar rooftop system by most of the States in the country.



**Fig 3.2:** Net Metering Method

On a cloudy or rainy day when your panels aren't producing enough energy, the utility grid will feed home energy, and count that energy against the credits you've banked over time. As a solar customer, will only be billed for your "net" energy usage. Also known as net energy metering or NEM, net metering is the solar industry's foundational policy.

**SESSION 01**

**Check Your Progress**

**A. Short Answer Question**

1. What do you mean by life cycle cost?
2. What is gross metering

3. Explain the net metering concept.
4. Write the list of five solar water pumping system manufacturers

### **B. Multiple choices Question**

1. **a mechanism in which the entire energy generated by your solar system is exported to the grid at a certain rate**
  - a) Net meter
  - b) Gross meter
  - c) a and b
  - d) None of the above
2. **The units of electricity produced by the solar system are taken into account and adjusted in the electricity bill at the same tariff at which the electricity is charged in the bill. what is the name of that technique.**
  - a) Net meter
  - b) Gross meter
  - c) Volt meter
  - d) None of the above
3. **The concept of Net Metering is related to**
  - a) Sewage dumping in the ocean and sea
  - b) Electricity lost during distribution
  - c) Solar energy generation
  - d) Amount of natural gas wasted during transportation
4. **The full form LCC .....**
  - a) Life Cycle Cost
  - b) Life Cost Cycle
  - c) Life Circle Cost
  - d) None of the above

### **ANSWER**

- 1) a) Net meter
- 2) b) Gross meter
- 3) c) Solar energy generation
- 4) a) Life Cycle Cost



## **SESSION 02:**

### **BUSINESS STRATEGIES AND GOVERNMENT SCHEMES AND POLICY**

**BUSINESS STRATEGIES:** A business strategy is the combination of all the decisions taken and actions performed by the business to accomplish business goals and to secure a competitive position in the market.

It is the backbone of the business as it is the roadmap that leads to the desired goals. Any fault in this roadmap can result in the business getting lost in the crowd of overwhelming competitors.

**Importance of Business Strategy:** A business objective without a strategy is just a dream. It is no less than a gamble if you enter the market without a well-planned strategy.

With the increase in the competition, the importance of business strategy is becoming apparent and there's a huge increase in the types of business strategies used by the businesses. Here are five reasons why a strategy is necessary for the business.

- **Planning:** Business strategy is a part of a business plan. While the business plan sets the goals and objectives, the strategy gives you a way to fulfil those goals. It is a plan to reach where you intend to.
- **Strengths and Weaknesses:** Most of the time, you get to know about your real strengths and weaknesses while formulating a strategy. Moreover, it also helps you capitalise on what you're good at and use that to overshadow your weaknesses (or eliminate them).
- **Efficiency and Effectiveness:** When every step is planned, every resource is allocated, and everyone knows what is to be done, business activities become more efficient and effective automatically.
- **Competitive Advantage:** A business strategy focuses on capitalising on the strengths of the business and using it as a competitive advantage to position the brand in a unique way. This gives an identity to a business and makes it unique in the eyes of the customer.
- **Control:** It also decides the path to be followed and interim goals to be achieved. This makes it easy to control the activities and see if they are going as planned.

The business strategy is a part of the business plan which is a part of the big conceptual structure called the business model.

The business model is a conceptual structure that explains how the company operates, makes money, and how it intends to achieve its goals. The business plan defines those goals, and business strategies outline the roadmap of how to achieve them.

**Main Components of a Business Strategy:**

While an objective is defined clearly in the business plan, the strategy answers all the what’s, whys, who’s, where’s, when’s, & how’s of fulfilling that objective. Here are the key components of a business strategy.

- Mission
- Vision
- Business Objectives

The main focus of a business strategy is to fulfil the business objective. It gives the vision and direction to the business with clear instructions of what needs to be done, how it needs to be done, and who all are responsible for it.

Ways to Identify Business Opportunities Within the Business

1. **SWOT Analysis**

An excellent way to identify opportunities inside your business is by creating a SWOT analysis. The acronym SWOT stands for strengths, weaknesses, opportunities, and threats. SWOT analysis framework:

S Strengths	W Weaknesses	O Opportunities	T Threats
<ul style="list-style-type: none"> <li>• Things your company does well</li> <li>• Qualities that separate you from your competitors</li> <li>• Internal resources such as skilled and knowledgeable staff</li> <li>• Tangible assets such as intellectual property, capital proprietary technologies, etc.</li> </ul>	<ul style="list-style-type: none"> <li>• Things your company lacks</li> <li>• Things that your competitors do better than you</li> <li>• Resource limitations</li> <li>• Unclear unique selling proposition</li> </ul>	<ul style="list-style-type: none"> <li>• Underserved markets for specific products</li> <li>• Few competitors in your area</li> <li>• Emerging need for your products or services</li> <li>• Press/media coverage of your company</li> </ul>	<ul style="list-style-type: none"> <li>• Emerging competitors</li> <li>• Changing regulatory environment</li> <li>• Negative press/media coverage</li> <li>• Changing customer attitudes towards your company</li> </ul>

**Fig 3.3:** SWOT Analysis

By looking at self and your competitors using the SWOT framework, can uncover opportunities that can exploit, as well as manage and eliminate threats that could derail your success.

## 2. **Establishing Your USP (Unique Selling Proposition)**

Establish your USP and position yourself as different from your competitors.

Identify why customers should buy from you and promote that reason.

**Marketing Strategy:** Renewable energy is blowing up in the consumer, commercial, and industrial sectors right now. And the core of that explosion is solar energy. Marketing is a dynamic and ever-changing field. The top digital marketing strategies change with the consumer and technology trends of the day. This is why every company needs a good marketing strategy that's well-planned and has well-defined milestones and objectives. Once you have the right map, the chances you'll reach the goals you've set for your business, are much higher.

Market research is the process of gathering, analysing, and interpreting market information on a product or service that is being sold in that market. It also includes information on:

- Past present, and prospective customers
- Customer characteristics and spending habits
- The location and needs of the target market
- The overall industry
- Relevant competitors

Market research involves two types of data:

1. Primary information. This is research collected by yourself or by someone hired by you.
2. Secondary information. This is research that already exists and is out there for you to find and use.



**Fig 3.4:** Marketing plan

### **Primary research can be of two types:**

- Exploratory: This is open-ended and usually involves detailed, unstructured interviews.
- Specific: This is precise and involves structured, formal interviews. Conducting specific research is more expensive than conducting exploratory research.

### **Secondary research**

Secondary research uses outside information. Some common secondary sources are:

Public sources: These are usually free and have a lot of good information. Examples are government departments, business departments of public libraries, etc.

Commercial sources: These offer valuable information but usually require a fee to be paid. Examples are research and trade associations, banks and other financial institutions, etc.

Educational institutions: These offer a wealth of information. Examples are colleges, universities, technical institutes, etc.

### **THE 4 Ps OF MARKETING:**

The 4 Ps of marketing is marketing is a concept that summarizes the four basic pillars of any marketing strategy.

#### **The four Ps of marketing are:**

**Product:** What you sell. Could be physical goods, services, consulting, etc.

**Price:** How much do you charge and how does that impact how your customers view your brand?

**Place:** Where do you promote your product or service? Where do your ideal customers go to find information about your industry?

**Promotion:** How do your customers find out about you? What strategies do you use and are they effective?

## **Marketing Strategies to Fuel Your Business Growth**

- Content Marketing
- Use Videos as Marketing Tools
- Social Media Marketing
- Email Marketing
- Search Engine Optimization
- Referral Programs
- Industry Events
- Conversational Marketing

## **GOVERNMENT POLICIES AND SCHEME:**

The current energy requirement in India is heavily dependent on conventional energy sources. The Indian government acknowledges the increasing concern related to climate change and global warming and has recognised the urgent need to address these issues. The promotion of renewable energy and solar industrial growth is one of the key measures taken by the government in this direction. Today Renewable Energy is increasingly becoming an integral part of energy security initiatives in India. The Indian government has been promoting the setting up of Renewable Energy based power plants through various policy initiatives and Incentives for Investors, Developers, and consumers. The government had earlier issued the Incentive Policy for Encouraging the generation of power in India through Non-Conventional Energy Sources. The Ministry of New and Renewable Energy (MNRE) is the nodal Ministry of the Government of India for all matters relating to new and renewable energy. The broad aim of the ministry is to develop and deploy new and renewable energy for supplementing the energy requirements of the country. They provide direct and indirect tax benefits such as sales tax, excise duty exemptions, and custom duty exemptions. A few important policy names are given below-

- Electricity Act, 2003
- National Electricity Policy, 2005
- Tariff Policy, 2006
- Jawaharlal Nehru National Solar Mission (JNNSM), 2010
- The National Tariff Policy, 2016

India is blessed with abundant solar energy potential with 300 days of sunlight.

About 5,000 trillion kWh per year of energy is experienced over India's land area with most parts receiving 4-7 kWh per sq. m per day. The government henceforth aims to create solar schemes to use this renewable source of energy efficiently. Below is a list of some of the most successful and known solar schemes in India –

- 1. PM Kusum Scheme:**
- 2. Surya Mitra Skill Development Programme**
- 3. Grid-connected Rooftop Scheme**
- 4. Development of Solar Park Scheme**

#### **PM KUSUM SCHEME:**

##### ***(Pradhan Mantri Kisan Urja Suraksha Evam Utthaan Mahabhiyan)***

The Government of India launched KUSUM Scheme or Pradhan Mantri Kisan Urja Surakshaevam Utthaan Mahabhiyan Yojana in March 2019. This scheme was announced by the Ministry of New and Renewable Energy (MNRE), aiming for growth in income for Indian farmers.

Pradhan Mantri Kisan Urja Suraksha Evam Utthaan Mahabhiyan Yojana is a scheme to subsidise farmers to install solar irrigation pumps for cultivation. Each farmer will receive a 60% subsidy to set up tube wells and pump sets. They will also get 30% of the total cost as a loan from the Government.

#### **Objectives of the PM-KUSUM Scheme**

The primary objective of the PM KUSUM scheme is to make cutting-edge technology available to our farmers and provide sources for de-dieselised irrigation to the agricultural sector. The main objectives of this scheme are:

The solar pumps assist our farmers in much more effective and eco-friendly irrigation as these are capable of generating safer energy.

In addition, the pump sets comprise an energy power grid that generates more energy than diesel-driven pumps. Farmers will be able to sell the extra power to our government directly to enhance their income.

Features or components of the KUSUM Scheme

#### **The KUSUM scheme comprises 3 components that have different features:**

**Component A:** Install a total of 10 GW grid-connected stilt-mounted decentralised solar plants and other renewable energy-based power plants. Each plant is sized up to 500KW to 2MW.

**Component B:** Installation of 17.50 lakh standalone Solar powered agriculture pumps of individual pump capacity up to 7.5 HP.

**Component C:** Installation of 10 Lakh grid-connected agriculture pumps of individual pump capacity up to 7.5 HP.

### **WHO IS ELIGIBLE FOR THE KUSUM SCHEME?**

**The eligible categories for KUSUM Scheme are:**

- An individual farmer.
- A group of farmers.
- Farmer producer organization.
- Panchayat.
- Co-operatives.
- Water User Associations.

### **BENEFITS OF THE KUSUM SCHEME:**

**This scheme provides the following benefits:**

- The Indian government initiated the construction of solar plants that can generate an aggregate of 28,250 MW of power.
- The Government will subsidise 60% and provide a loan of 30% of the total cost. This leads our farmers to bear only 10% of the total cost to install solar plants and solar pumps.
- As per the KUSUM Scheme details, our government will provide subsidies to install state-of-the-art solar pumps. They improve irrigation as they hold 720 MW of capacity.
- This scheme offers our farmers an opportunity of selling the extra power generated by the plants directly to our government. This ensures the scope of increase in the income of our farmers.
- A landholder in a rural area can get a stable source of income by utilising barren and uncultivated land for solar plant implementation for 25 years.
- The solar plants will be set up above a minimum height in cultivable lands. This way, our farmers will be able to continue with cultivation after installing the plants.
- KUSUM Scheme ensures increasing the use of renewable energy helps to mitigate pollution in farms and opens a gateway to eco-friendly cultivation.

## **DOCUMENTS REQUIRED TO APPLY FOR THE KUSUM SCHEME**

- Aadhar card
- A land document including Khasra Khatauni
- A bank account passbook
- A declaration forms
- Mobile number
- Passport size photo

After a successful online application for KUSUM Scheme, farmers must deposit 10% of the total cost to set up a solar pump to the supplier sent by the department. The solar pump set will be empowered after the subsidy amount gets sanctioned, which generally takes 90 to 100 days.

The PM KUSUM Scheme aims to promote the use of renewable energy in the agricultural sector and offer the benefits of solar farming to Indian farmers and farmers can sell the extra energy generated from the solar plants directly to the Government of India. This is one of the greatest benefits of the KUSUM Scheme that will allow our farmers to increase their earnings.

## **2. SURYA MITRA SKILL DEVELOPMENT PROGRAMME**

The National Institute of Solar Energy (NISE), an autonomous institution of the Ministry of New and Renewable Energy (MNRE), is the apex National R&D institution in the field of Solar Energy. NISE is organizing “Surya Mitra” skill development programmes in collaboration with State Nodal Agencies, at various locations across the country.

The programme aims to develop the skills of youth, considering the opportunities for employment in the growing Solar Energy Power project’s installation, operation & maintenance in India and abroad. The Surya Mitra Programme is also designed to prepare the candidates to become new entrepreneurs in the Solar Energy sector. The surya mitra skill development programmes are sponsored by the Ministry of New & Renewable Energy, Government of India.



## **WORK EFFECTIVE AND ANNUAL MAINTENANCE**

After the system has been installed and commissioned, the focus shifts to O&M (operation and maintenance) throughout its lifetime. System operation can be optimized by closely monitoring and recording key system parameters (data logging), enabling operators to assess system performance or demand changes.

The supplier provides an annual maintenance contract to the beneficiary after an initial guarantee period of 5 years. The solar panel is expected to provide about 20 years of satisfactory service under normal conditions, even though the cell itself may last much longer. The only maintenance required is occasional washing of the surface to maintain maximum optical transmission through the glass. The panel has to be protected from breakage by external agencies. Some manufacturers cover the cell/array with unbreakable glass. The motor and the pump require the usual periodic maintenance like cleaning, lubrication, and replacement of worn parts.

The contractor will have full responsibility for the repair and maintenance of the solar pumping system already installed at various locations in India. This will include all the minor wear and tear of equipment, regular service of the Pump, and replacement of spares (excluding the items/spares).

The contractor will have to do the periodic check by visiting at least once in a quarter to each pump location and doing the routine check-up and maintenance of the pumps. Other than the periodic visits contractor has to visit the pump location for repair & maintenance purposes as and when required.

To ensure 100% working status during the annual maintenance cyclic period, the vender will have to arrange all required instruments, tools, spares, manpower, and other necessary facilities at the local service center.

The maintenance service provided shall ensure the proper functioning of the SPV water pumping system as a whole. All preventive/routine maintenance required for ensuring maximum uptime shall have to be provided for a specified period.

## **SESSION 2**

### **Check Your Progress**

#### **A. Short Answer Question**

1. Explain the 4Ps
2. Write down a short note on marketing
3. Write a short note on the PM-KUSUM scheme.
4. Create a list of solar schemes

5. Write a short note on Surya Mitra Skill Development Programme

**B. Fill in the blank**

1. The full form of JNNSM is .....
2. Full form of SWOT .....
3. In Kusum scheme Component “A” Install a total of 10 GW grid-connected stilt-mounted decentralized solar plants and other renewable energy-based power plants. Each plant is a capacity up to.....
4. The Government of India launched KUSUM Scheme or Pradhan Mantri Kisan Urja Suraksha Evam Utthaan Mahabhiyan Yojana in the year of .....

**Answer.**

1. **Jawaharlal Nehru National Solar Mission (JNNSM),**
2. **Strengths, Weaknesses, Opportunities, and Threats.**
3. **500KW to 2MW**
4. **March 2019**

**C. Multiple choices Question**

1. In Which Components Installation of 17.50 lakh standalone Solar Powered Agriculture Pumps of individual pump capacity up to 7.5 HP?
  - a) Component A
  - b) Component B
  - c) Component C
  - d) Component D
2. In which installation of 10 Lakh Grid-connected Agriculture Pumps of individual pump capacity up to 7.5 HP.
  - a) Component A
  - b) Component B
  - c) Component C
  - d) None of the above
3. What is a skill development programme that aims to develop the skills of youth, considering the opportunities for employment in the growing Solar energy power projects?
  - a) Surya Mitra Skill Development Programme

- b) Skill India Mission
- c) Make in India
- d) All of the above

4. In SWOT analysis “T” stands ....

- a) True
- b) Threat
- c) Trainer
- d) Team

**ANSWER**

- 1) a) Component B
- 2) c) Component C
- 3) a) Surya Mitra Skill Development Programme
- 4) b) Threat

<b>Module 4</b>	<b>Innovation and Development in Solar Energy</b>
<b>Module Overview</b>	
This module focuses on the latest advancements and innovations in solar energy, highlighting the cutting-edge developments that are shaping the future of the industry. It covers both product innovations and new solar technologies that are driving increased efficiency and expanding the applications of solar power.	
<b>Learning Outcomes</b>	
<ul style="list-style-type: none"> <li>• Describe the innovations in different solar products</li> <li>• Explain new solar technology</li> </ul>	
<b>Module Structure</b>	
Session 01: Innovations in the Field of Solar Energy Products	
Session 02: New Solar Technologies	

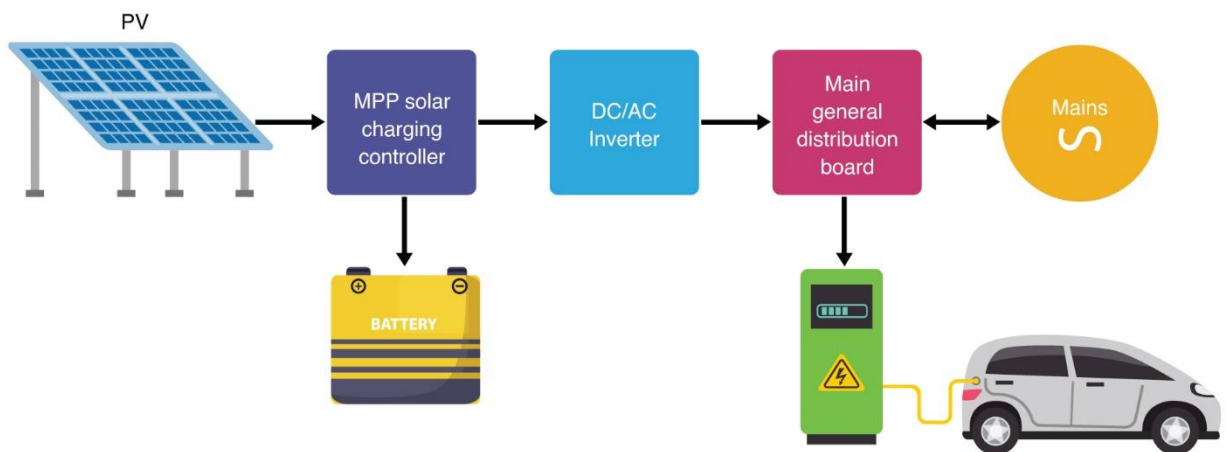
India aims to achieve 100GW of solar power production by 2022. At first, such an ambitious project may seem like a herculean task. But on the other hand, it may not be too difficult for the country to achieve its long-term energy goals. India aims to achieve 450 GW of Renewable energy capacities by 2030, of which about 280 GW is expected to be solar energy. There is a huge potential in the country for solar power due to the geographical location and terrain of the country.

### **SESSION 1**

#### **Innovations in the field of solar energy products**

The field of solar energy is continuously undergoing innovation and discoveries. In the last few years, various products developed in solar industries like home lighting systems, lanterns, solar water heaters, cooling, space heating, solar cookers, solar power banks, solar street lights, solar balloons, solar water RO, solar e-rickshaw, solar charging stations, etc. few of them we discuss below-

1. **Solar charging station:** The solar charging station gives the electricity to charge the Battery. A solar charging station is meant so that vehicles are fully charged and environmentally safe. This technique transforms solar power into electricity and stores it in a battery bank. Road transport is undoubtedly the most common and affordable form of commute for people around the world. However, recently, it has faced much criticism due to its dependence on fossil fuels and its relatively low operational efficiency. This has opened the doors for the electric mobility industry, and the world has witnessed a drastic surge in the acceptability of EVs. India's first solar-powered EV charging station was installed in Mumbai. Its name is "ATUM Charge", India's first 100 percent self-sustaining solar-powered EV charging station.



**Fig. 4.1:** Solar charging station

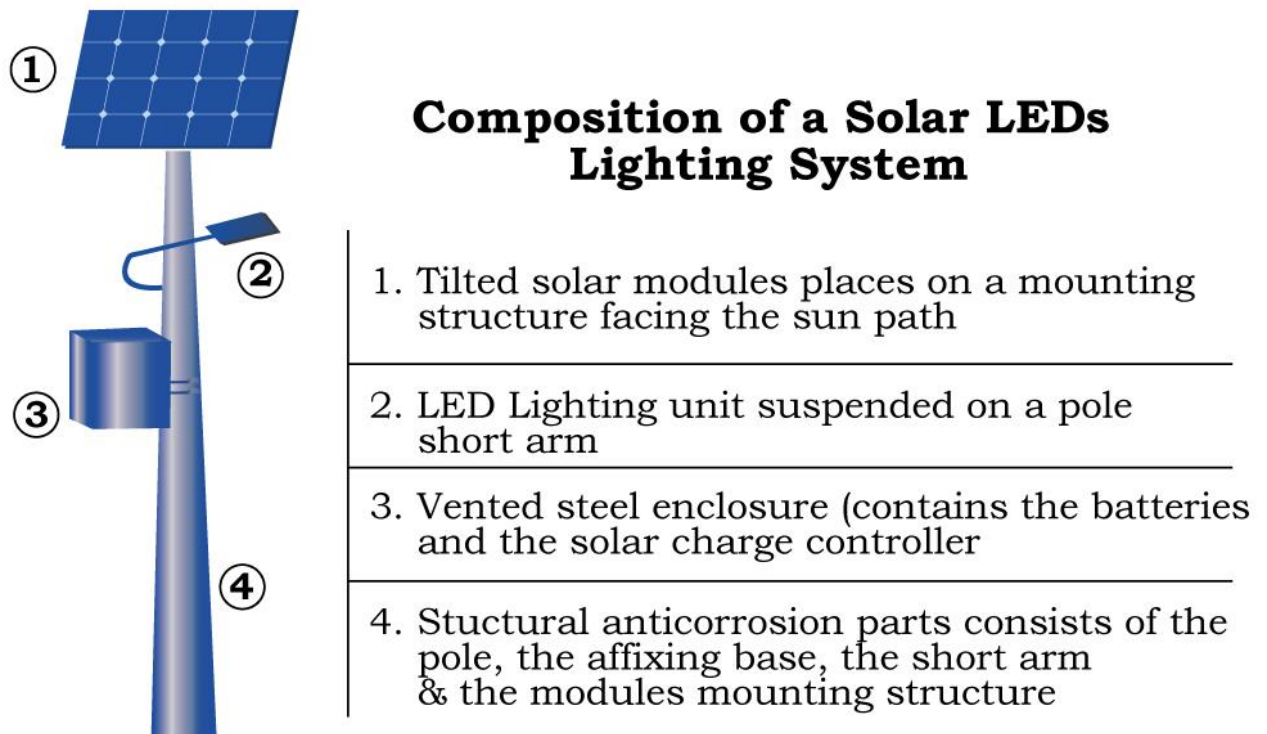
### ***Benefits of Solar Electric Battery Charging***

- Clean, & easy to use.
- Solar power maximizes battery life.
- It's safe and reliable.
- Zero carbon footprint
- Government incentives and tax credits

### **2. Solar Street Light:**

A standalone solar photovoltaic street lighting system is an outdoor lighting unit used for illuminating a street or an open area. Recent advances in LED lighting have brought very promising opportunities for application in street lighting.

Combining LED's low power, and high illumination characteristics with current photovoltaic (PV) technology, PV-powered street light utilizing LED has become a norm in many places. In today's application, most of the common High-Intensity Discharge (HID) lamps, often High-Pressure Sodium (HPS) lamps are being replaced by more low powered Light Emitting Diode (LED) lamps.



**Fig. 4.2:** Solar Street Light

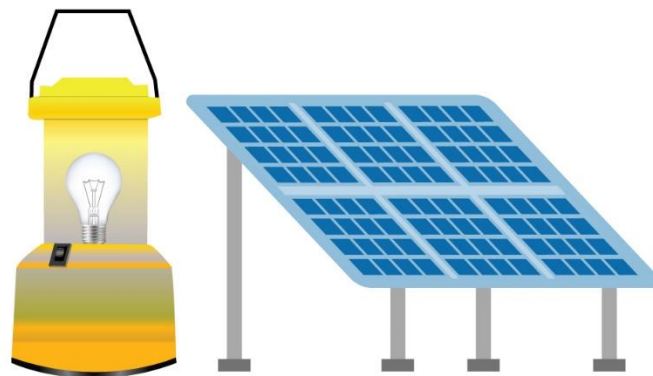
A basic solar-powered LED street light system components are:

1. Solar panel or photovoltaic module
2. Lighting fixture – LED lamp set
3. Rechargeable deep cycle battery
4. Solar charge controller
5. Light pole

The solar panel will provide electricity to charge the battery during the daytime. the battery's charging is controlled by a charge controller. the operation of the led bulb is controlled by a control circuit either by using sensors such as light dependent resistor (LDR) or a voltage or current sensor. all these components will be fixed on a pole as shown in figure 4.2. the solar panel is mounted at the top of the pole to minimize the possibility of any shading on the panels. lead-acid was the popular choice of batteries for solar street lights earlier as they were relatively inexpensive and were available for a variety of applications. they demand bigger

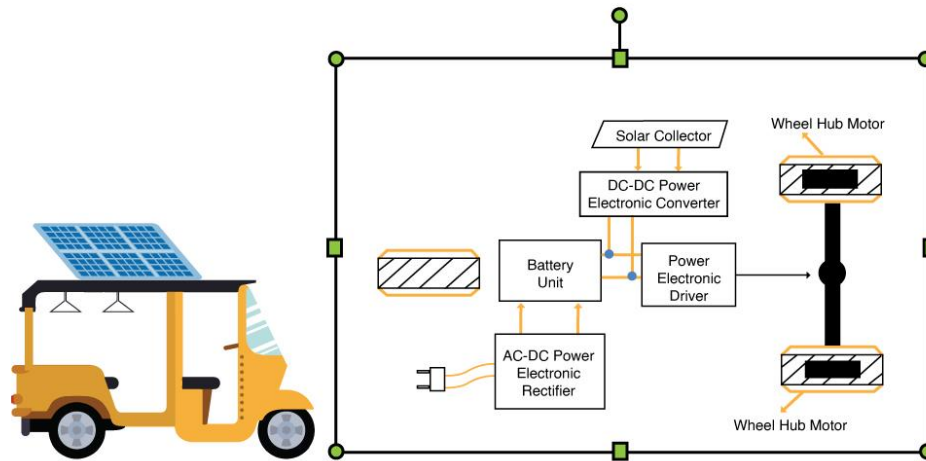
solar panels for charging and the panels are required to produce 12 v to charge the batteries, hence their effectiveness is not at its best during cloudy and rainy days. Modern solar streetlights consist of 3.7 or 3.2-volt lithium-ion or LiFePO<sub>4</sub> batteries so the solar panels do not need to produce a lot of currents to charge these batteries. They are compact, have a longer lifespan and demand hardly any maintenance.

3. **Solar Lantern:** A Solar lantern is a simple application of solar photovoltaic technology, which has found good acceptance in rural regions where the power supply is irregular and scarce. Even in urban areas, people prefer a solar lantern as an alternative during power cuts because of its simple mechanism. A solar lantern is made of three main components - the solar PV panel, the storage battery and the lamp. The operation is very simple. The solar energy is converted to electrical energy by the SPV panel and stored in a sealed maintenance-free battery for later use during the night hours. A single charge can operate the lamp for about 4-5 hours.



**Fig. 4.3:** Solar Lantern

4. **Solar rickshaw:** A solar rickshaw is a vehicle, usually three-wheeled, driven by an electric motor and powered either by solar panels or by a battery charged by solar panels. The e-rickshaws do not emit smoke and hence they are non-polluting. They don't use petrol and diesel. Economically compared to other types of vehicles, e-rickshaws are quite cheap and can easily be afforded by a common man.



**Fig. 4.4:** E-rickshaws

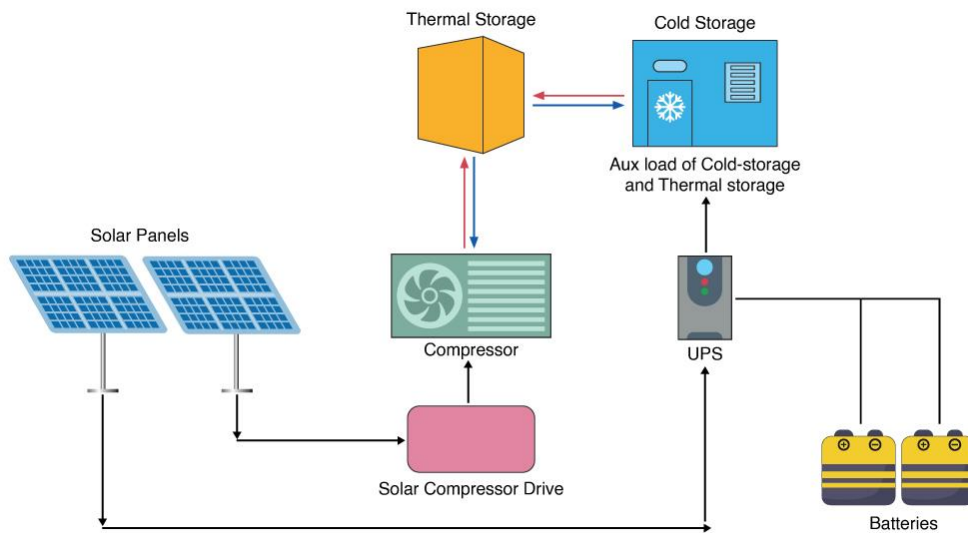
E-Rickshaw is the most commonly used vehicle for short distances throughout the world. As these E-Rickshaws have no pollution, no sound, and are easy to operate.

### **Solar Powered Cold Storage System**

In a solar-powered cold storage system cooling takes place by solar energy. During the daytime, the Cold room is run by the electricity produced from Solar Photovoltaic panels. The excess energy stored in the panels during the day is stored in the form of Latent Heat Energy of Thermal Energy Storage to be utilized in night. In the daytime, two operations take place simultaneously- one for the charging process of the thermal energy storage (TES) and the second for the direct cooling in the Cold Storage by running the compressor.

In the night-time, the energy stored in the TES in the form of solidified ice is utilized by circulating the Refrigerant R-134a and delivering the cold air through the evaporator of the Cold Storage. The schematic functioning of the solar cold storage is shown in Figur 4.5 The cost of a 5-ton capacity solar-powered cold storage system is about Rs. 8-10 lakh.

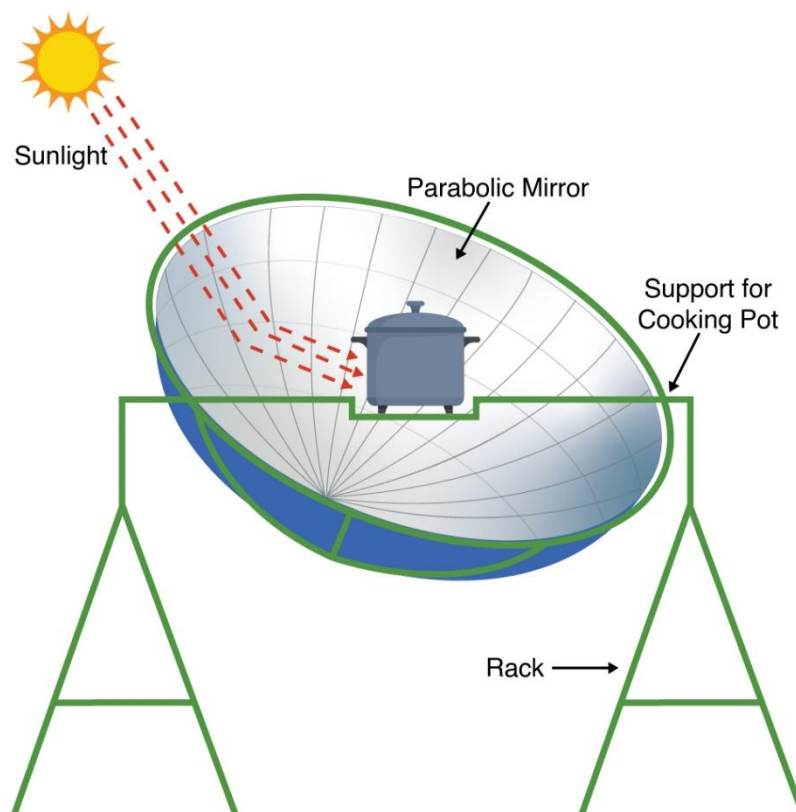




**Fig.4.5:** A solar-powered cold storage system

### Dish Type Solar Cooker

Dish-type cookers produce the highest temperature and can be used to fry or grill food; pot lids and cooking bags are not necessary. It uses a dish of parabolic shape to concentrate a large amount of sunlight into a single focal point, where the temperature can reach up to 450°C. It can cook food in lesser time than a box solar cooker. It costs about Rs. 8000-10000/-.



**Fig.4.6:** Dish Type Solar Cooker

### **Solar Powered Water ATM**

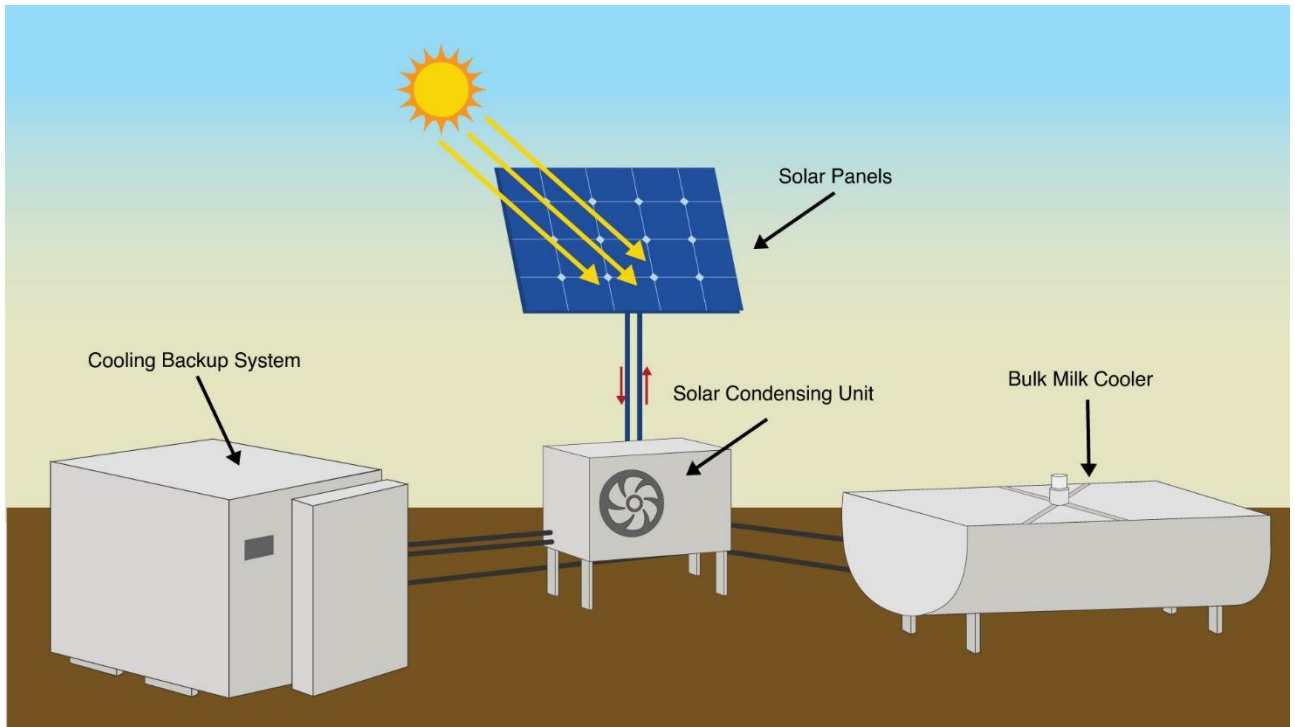
A solar-powered water ATM is a clean water dispensing machine in which RO quality drinking water is supplied. The water is purified using the solar electricity produced from solar photovoltaic panels to run an RO system. The card is used to dispense the water of any desired quantity i.e. 10,20,30,50-liter bottles.



**Fig.4.7:** Solar-Powered Water ATM

### **Solar Powered Bulk Milk Chiller**

The solar-powered bulk milk chiller is suitable for preserving the milk collected in village-level cooperatives before transferring it to the main dairies. It works on a similar principle to solar cold storage. During the daytime, the milk tank is collected by the electricity produced from Solar Photovoltaic panels. The excess energy stored in the thermal battery during the day is stored in the form of latent heat energy of thermal energy storage to be utilized in night. The cost of a 500-liter capacity is about rs. 8.00 lakh.



**Fig.4.8:** Solar-Powered Bulk Milk Chiller

## SESSION 1

### Practical Exercise

1. Create a list of products powered by sunlight.
2. Draw the line diagram of e-rickshaw
3. Write the main components of the solar street light.
4. Draw a line diagram of the solar charging station.

### Check Your Progress

#### A. Short Answer Question

1. What is a solar charging station?
2. What are the advantages of solar streetlights?
3. Which battery is used in e rickshaw?
4. Write the advantages of e-rickshaw.

#### B. Fill in the blank

1. The full form of LED is .....
2. .... type of battery used in solar street light
3. In battery "**Ah**" indicates.....

4. A Solar Lantern is a simple application of .....technology

**Answer.**

**1. Light Emitting Diode**

**2. lithium-ion**

**3. Amp-hours (Ah)**

**4. solar photovoltaic.**

**C. Multiple choices Question**

1. A fast-charging station called....

- a) DC Charging
- b) AC Charging
- c) a & b
- d) None of the above

2. In which solar product battery is the use?

- a) E-Rickshaws
- b) Solar Street Light
- c) Solar Lantern
- d) all of the above

3. India's First Solar-Powered EV Charging Station Installed in Mumbai. Its name is

- a) ATUM Charge
- b) Quantum charge
- c) Atom charge
- d) Electron charge

4. Zero Carbon Footprint means

- a) Releasing Greenhouse Gases
- b) Releasing No Greenhouse Gases
- c) a & b
- d) none of the above

**ANSWER**

**1. a) DC Charging      2.d) all of the above**

**3. a) ATUM Charge      4. b) Releasing No Greenhouse Gases**

## **SESSION 2: NEW SOLAR TECHNOLOGIES**

Solar energy, the third-largest renewable energy source after hydropower and wind has emerged as a clean, sustainable, and powerful alternative to fossil fuels. The sunlight striking the Earth is more than 10,000 times the world's total energy use, and technologies to harvest as much solar energy as possible are surging rapidly. the most common technologies today use different forms of Si-based solar cells and convert up to 20% of the sunlight to electricity.

A typical solar cell consists of semiconducting materials such as p- and n-type silicon with a layered p-n junction connected to an external circuit. Sunlight illumination on the panels causes electron ejection from silicon. The ejected electrons under an internal electric field create a flow through the p-n junction and the external circuit, resulting in a current (electricity).

Currently, several exciting new solar panel technologies are either in the line or already on the market. These promising technologies will transform the way we think about not just solar, but energy production in general.

There are various New Solar technologies in the world few are of them we discuss:

### **1. BIPV solar technology:**

Building-integrated photovoltaics, as the name suggests, seamlessly blend into building architecture in the form of roofs, curtain walls, facades, and skylight systems. Unlike traditional solar PV panels, BIPV can be aesthetically appealing rather than a compromise to a building's design.

The good news is that the BIPV solar panel systems enable homeowners to save on building materials and electric power costs. By substituting BIPV for standard building materials, you can cut down on the additional cost of solar panel mounting systems.

BIPV technology, when used on the building's facades, atrium, terrace floor, and canopies, provides the following benefits:

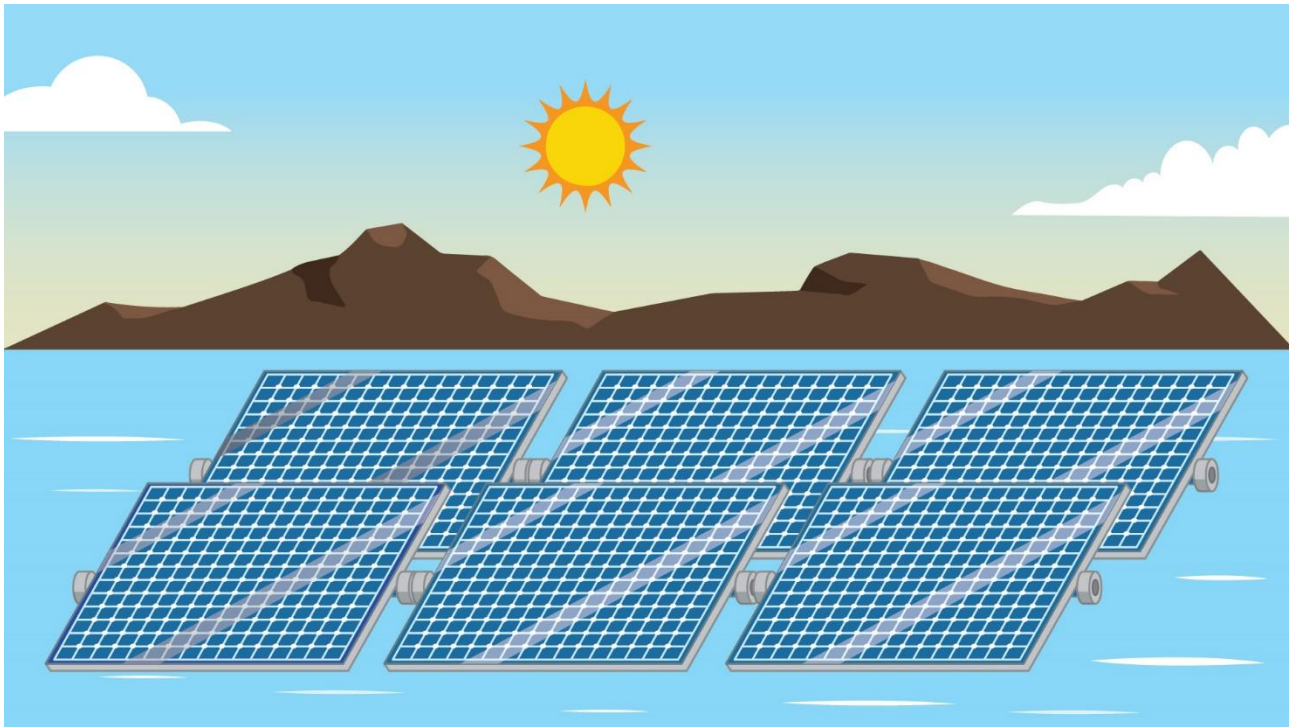
- Increased energy efficiency.
- High thermal and sound insulation.
- Clean and free power output from the sun.
- Decreased O&M costs.
- Zero carbon footprint.

The photovoltaic PV glasses installed as building materials act as an energy-

generating device, allowing natural light inside homes and offices, just as conventional architectural glasses.

## **2. Floating solar plants/farms:**

Floating solar PV plants are an emerging form of PV systems that float on the surface of drinking water reservoirs, quarry lakes, irrigation canals, or remediation and tailing ponds. They consist of a floating system. Also known as a pontoon, it is a sturdy structure that holds the solar panel.

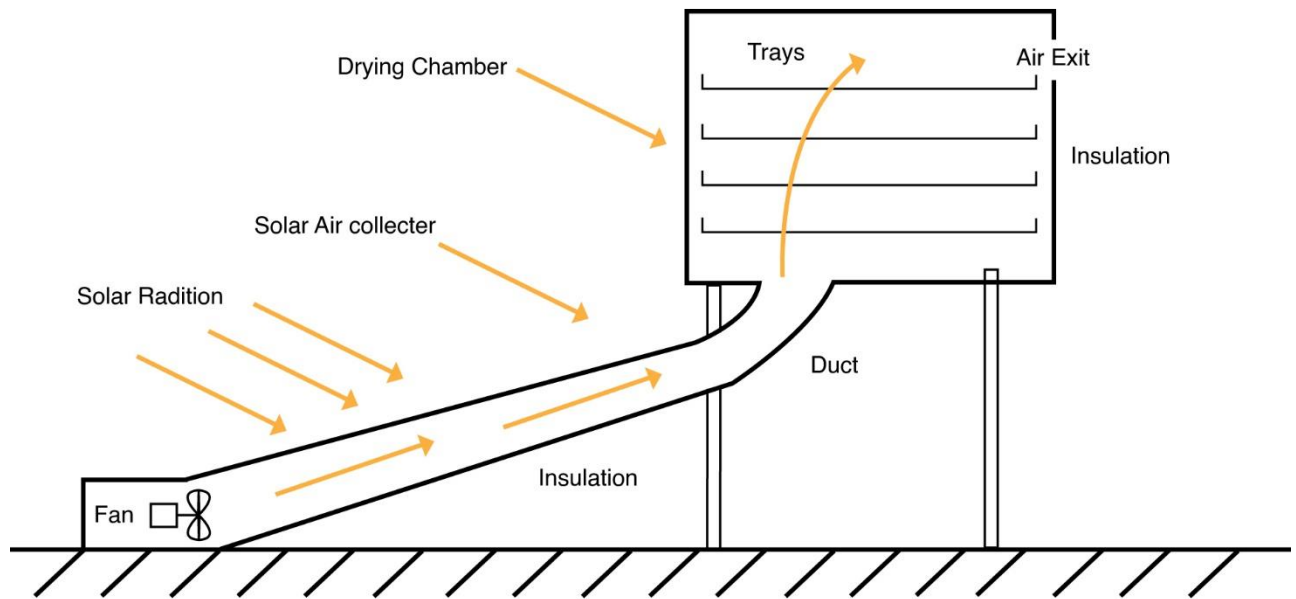


**Fig. 4.5:** Floating solar plant/farms

India's biggest floating solar power plant by generation capacity (100MW) is being developed by the National Thermal Power Corporation Limited (NTPC) at Ramagundam in the Peddapalli district of Telangana.

The main advantage of floating solar plants is that they do not take up any land, except for the limited surfaces necessary for electric cabinet and grid connections. Their price is comparable with land-based plants, but they provide a good way to avoid land consumption.

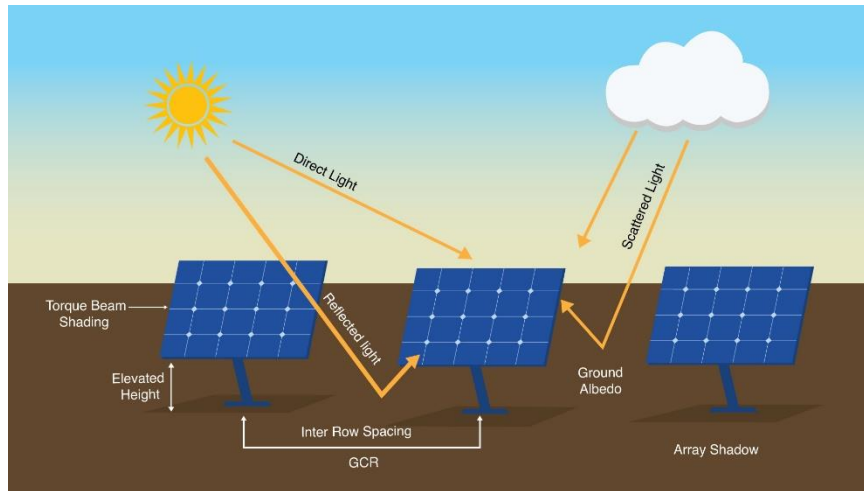
**3. Solar dryer:** The principle of the solar drying technique is to collect solar energy by heating up the air volume in solar collectors and conduct the hot air from the collector to an attached enclosure, the meat drying chamber. Here the products to be dried are laid out.



**Fig. 4.6:** Solar dryer

In this closed system, consisting of a solar collector and a meat drying chamber, without direct exposure of the meat to the environment, meat drying is more hygienic as there is no secondary contamination of the products through rain, dust, insects, rodents or birds. The products are dried by hot air only. There is no direct impact of solar radiation (sunshine) on the product. Solar energy produces hot air in the solar collectors. Increasing the temperature in a given volume of air decreases the relative air humidity and increases the water absorption capacity of the air. A steady stream of hot air into the drying chamber circulating through and over the meat pieces result in continuous and efficient dehydration.

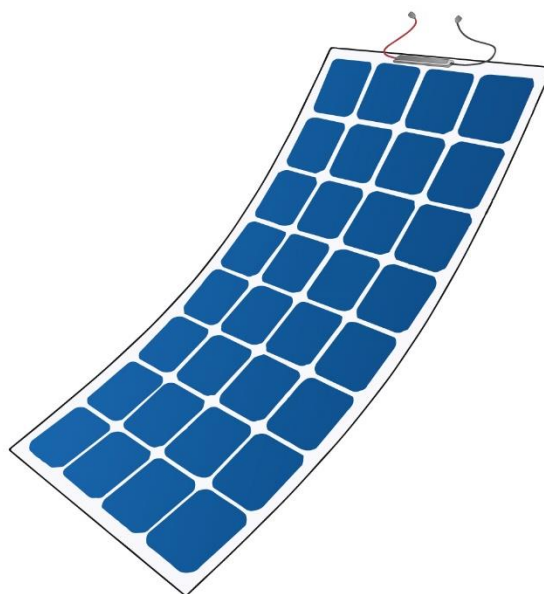
**Bifacial solar module:** Bifacial modules produce solar power from both sides of the panel. Bifacial solar modules offer many advantages over traditional solar panels. Power can be produced from both sides of a bifacial module, increasing total energy generation.



**Fig.4.7:** Bifacial solar panel

Sun Power is one of the most well-known companies in the solar industry. The new bifacial solar panel conversion efficiency is up to 27%. The main advantages of this panel are increased energy generation, the small space required for installation, and energy generated in cloudy or bad weather.

**Flexible solar panels:** There are different types of solar panels available in the market. The three main types are monocrystalline, polycrystalline and thin-film solar panels – all of which differ based on the purity of the material that they are made from (usually silicon). While the monocrystalline and polycrystalline panels are quite similar, they differ when it comes to the finer details. Monocrystalline solar panels are more space-efficient and powerful, while thin-film cells belong to an entirely different category.



**Fig.4.8:** Flexible solar panels



Flexible solar panels are ideal for portable solar applications given their light weight.

### **STANDARDS OF SOLAR PANELS:**

The safe and reliable installation of photovoltaic (PV) solar energy systems and their integration with the nation's electric grid requires the timely development of the foundational codes and standards governing solar deployment. Standards are norms or requirements that establish a basis for the common understanding and judgment of materials, products, and processes. Standards are an invaluable tool in industry and business because they streamline business practices and provide a level playing field for businesses to develop products and services. They are also critical to ensuring that products and services are safe for consumers and the environment. The Solar Energy industry relies on standardization for many things, including testing energy conversion, reflectance or materials properties, fabricating arrays, integrating into the smart grid, or assuring workplace safety. Numerous national and international bodies set standards for photovoltaic.

### **INTERNATIONAL ELECTROTECHNICAL COMMISSION (IEC) CODES**

The International Electro-Technical Commission (IEC) is the leading global organization that develops and publishes consensus-based International Standards for electric and electronic products, systems, and services, collectively known as electrotechnology. A few IEC CODES discuss below

#### **Balance of System-**

**IEC 62093:2005:** Balance-of-system components for photovoltaic systems - design qualification natural environments

**IEC 62109-1:2010:** Safety of power converters for use in photovoltaic power systems - part 1: general requirements

**IEC 62109-2:2011:** Safety of power converters for use in photovoltaic power systems - part 2: particular requirements for inverters

**IEC 60269-6 ed1.0:** Low-voltage fuses - part 6: supplementary requirements for fuse-links for the protection of solar photovoltaic energy systems

#### **Characteristics-**

**IEC 61727 ed2.0:** Photovoltaic (PV) systems - characteristics of the utility interface.

#### **Commissioning-**

**IEC 62446-1:2016:** Photovoltaic (PV) Systems - requirements for testing,

Documentation, and Maintenance - Part 1: Grid-connected systems - documentation, commissioning tests, and inspection.

#### **Design-**

**IEC 62124 ed 1.0:** Photovoltaic (PV) stand-alone systems - design verification

**IEC 62253 ed 1.0:** Photovoltaic pumping systems - design qualification and performance measurements

#### **Installation-**

**IEC 60364-1 ed5.0:** Low-voltage electrical installations - part 1: fundamental principles, assessment of general characteristics, definitions

**IEC 60364-7-712:2017:** Low-voltage electrical installations - part 7-712: requirements for special installations or locations - solar photovoltaic (PV) power supply systems

#### **Monitoring-**

**IEC 61724-1:2017:** Photovoltaic system performance - part 1: monitoring

**IEC TS 61724-2:2016:** Photovoltaic system performance - part 2: capacity evaluation method

**IEC TS 61724-3:2016:** Photovoltaic system performance - part 3: energy evaluation method.

#### **Performance-**

**IEC 62509 ed1.0:** Battery charge controllers for photovoltaic systems - performance and functioning.

#### **Rural Electrification**

**IEC TS 62257-1:2015:** Recommendations for renewable energy and hybrid systems for rural electrification - part 1: General introduction to IEC 62257 series and rural electrification

#### **Safety-**

**IEC 61730-1:2016:** Photovoltaic (PV) module safety qualification - part 1: requirements for construction

**IEC 61730-2:2016:** Photovoltaic (PV) module safety qualification - part 2: requirements for testing

#### **Terms-**

**IEC TS 61836:2016:** Solar photovoltaic energy systems - terms, definitions, and symbols

#### **Testing-**

**IEC 61215-1:2016:** Design qualifications & type approval part 1: testing

requirements (All chemistries)

**IEC 61215-2:2016:** Design qualifications & type approval part 2: testing procedures (all chemistries)

**IEC 62116:2014:** Utility-interconnected photovoltaic inverters - test procedure of islanding prevention measures

**IEC 62253:2011** Photovoltaic pumping systems – design qualification and performance measurements.

**BIS:**

The Full Form of BIS is the Bureau of Indian Standards. BIS is the National Standard Body of India established under the BIS Act 2016 for the harmonious development of the activities of standardization, marking and quality certification of goods and for matters connected therewith or incidental thereto. The Ministry of New and Renewable Energy (MNRE) has also issued the list of BIS standards applicable for components of solar PV applications. The Ministry of New and Renewable Energy (MNRE) is implementing a Quality Control Order on SPV Systems, Devices and Components Goods Order 2017 under BIS Act (Compulsory Registration Scheme). The said order includes SPV Modules, Inverter and Battery Storage with specified Indian Standards adopted from IEC Standards for these products.

**Table no. 4.1 Indian standards on renewable energy notified by BIS (Bureau of Indian Standards)**

<b>S.No.</b>	<b>Product</b>	<b>Standards</b>	<b>Remarks</b>
1.	Crystalline Silicon Terrestrial Photovoltaic (PV) modules (Si wafer-based)	IS 14286	Crystalline Silicon Terrestrial Photovoltaic (PV) modules– Design Qualification and Type Approval
2.	Thin-Film Terrestrial Photovoltaic (PV) Modules (a-Si, CiGs, and CdTe)	IS 16077	Thin-Film Terrestrial Photovoltaic (PV) Modules - Design Qualification and Type Approval
3.	PV Module (Si wafer and Thin-film)	IS/IEC 61730 (Part 1)	Photovoltaic (PV) module safety qualification part 1 requirements for construction

S.No.	Product	Standards	Remarks
		IS/IEC 61730 (Part 2)	Photovoltaic (PV)Module Safety Qualification Part 2 Requirements for Testing
4.	Power converters for use in photovoltaic power system	IS 16221 (Part 1)  IS 16221 (Part 2)	Safety of Power Converters for Use in Photovoltaic Power Systems Part 1- General Requirements  Safety of Power Converters for Use in Photovoltaic Power Systems Part 2- Particular Requirements for Inverters
5.	Utility –Interconnected Photovoltaic inverters	IS 16169	Test Procedure of Islanding Prevention Measures for Utility- Interconnected Photovoltaic Inverters
6.	Storage battery	IS 16270	Secondary Cells and Batteries for Solar Photovoltaic Application General Requirements and Methods of Test

## SESSION 2

### Practical Exercise

**Activity 01:** Draw the line diagram of the solar dryer.

Material required:

1. Pen
2. Drawing sheet
3. Pencil
4. Scale
5. Eraser

**Procedure:**

1. Take the permission from the solar dryer shop owner
2. Visit the shop
3. Identify the solar dryer in the shop

4. Write the specification of solar dryer specification
5. Draw a neat sketch of the solar dryer and label it.

### **Check Your Progress**

#### **A. Short Answer Question**

1. Explain the bifacial technology.
2. Write the five solar BIS codes with significance.
3. Write the advantages Bifacial module
4. What are BIS codes and their importance?
5. Write a short note on the Floating solar plant

#### **B. Fill in the blank**

1. The full form of IEC is .....
2. The full form of BIS is .....
3. IEC..... Code used for the design of solar photovoltaic pumping system.
4. Full form of BIPV.....

**Answer.1. International Electrotechnical Commission 2. Bureau of Indian Standards 3. IEC 62253:2011. 4. Building-integrated photovoltaics**

#### **C. Multiple choices Question**

1. Which IEC code gives details regarding Safety?
  - a) IEC 61724-1:2017
  - b) IEC 62446-1:2016
  - c) IEC 62116:2014
  - d) IEC 61730**
2. Which IS code gives details regarding Utility –Interconnected Photovoltaic inverters.
  - a) IEC 61730
  - b) IS 14286
  - c) IS 16169**
  - d) IS 16077
3. Which IS code gives details regarding Thin-Film Terrestrial Photovoltaic (PV) Modules
  - a) IS 16077**

- b) IS/IEC 61730 (Part 1)
  - c) IS/IEC 61730 (Part 2)
  - d) IS 16221 (Part 1)
- 4.** In which state India's biggest floating solar power plant by generation capacity (100MW) is being developed by the National Thermal Power Corporation Limited (NTPC) situated at-
- a) Telangana**
  - b) Tamil Nadu
  - c) Andhra Pradesh
  - d) Karnataka

**ANSWER**

1. d) IEC 61730 **2.** c) IS 16169 **3.** a) IS 16077) **4.** a) Telangana

## ANSWERS KEY

### Module 01: Installation and Commissioning of Solar Pumping System

#### Session 01: Site Survey and Selection of Site

Fill in The Blanks	Mark the Correct Options	Match the Following
1. Gallons Per Minute	1. a) Pyranometer	
2. 3.78 liters per minute	2. c) 746 watts	
3. 10 sq meter.	3. a) (m <sup>3</sup> /s)	
4. 4-7 kWh per sq. m per day	4. c) a & b	

#### Session 02: Selection of Solar Water Pumping System

Fill in The Blanks	Mark the Correct Options	Match the Following
1. variable frequency drive	1. d) a & c	
2. 6750 watts	2. a) Direct Driven SWP	
3. Uninterrupted	3. b) Battery-driven SWP system	
4. VFD	4. b) on grid SWPS	

#### Session 03: Design Criteria for Solar Water Pump System

Fill in The Blanks	Mark the Correct Options	Match the Following
1. Sum	1. a)	
2. Not wasting energy	2. a)	
3. Delivery head	3. b)	
4. Total head and discharge	4. a)	

Session 04: Material requirement and Construction of the foundation for the solar water

<b>Fill in The Blanks</b>	<b>Mark the Correct Options</b>	<b>Match the Following</b>
1. MC4 connectors	1. c)	
2. optimum tilt angle	2. c)	
3. controller	3. d)	
	4. d)	

**Module 02: Repair and Maintenance of Solar Pump**

Session 01: Cleaning and testing of solar panel

<b>Fill in The Blanks</b>	<b>Mark the Correct Options</b>	<b>Match the Following</b>
1. voltage, current, and resistance	1. b)	
2. Amperes	2. b)	
3. protected enclosure for electrical wiring	3. b)	
4. Continuity	4. a)	
	5. d)	

Session 02: Checking and identifying the different faults in the solar pumping system

<b>True and false</b>	<b>Mark the Correct Options</b>	<b>Match the Following</b>
1. True		1. c) If bad, replace it
2. True		2. d) Removal of the source
3. True		3. a) Cleaning
4. false		4. b) Repair/Replacement
5. True		



## Module 03: Cost Economics of Solar Pump and Opportunities

### Session 01: Economics

Fill in The Blanks	Mark the Correct Options	Match the Following
	1. a) Net meter	
	2. c) Gross meter	
	3. c) Solar energy generation	
	4. b) Life Cycle Cost	

### Session 02: Business Strategies, Government Scheme and Policy

Fill in The Blanks	Mark the Correct Options	Match the Following
1. Jawaharlal Nehru National Solar Mission	1. a)	
2. Strengths, Weaknesses, Opportunities, and Threats	2. c)	
3. 500KW to 2MW	3. a)	
4. March 2019	4. b)	

## Module 04: Innovation and Development in Solar Energy

### Session 01: Innovations in the field of solar and solar products

Fill in The Blanks	Mark the Correct Options	Match the Following
1. Light Emitting Diode	1. a) DC Charging	
2. lithium ion	2. d) all of the above	
3. Amp-hours (Ah)	3. a) ATUM Charge	
4. solar photovoltaic	4. b) Releasing No Greenhouse Gases	

### Session 02: New Solar Technology

<b>Fill in The Blanks</b>	<b>Mark the Correct Options</b>	<b>Match the Following</b>
1. International Electrotechnical Commission	1. d) IEC 61730	
2. Bureau of Indian Standards	2. c) IS 16169	
3. IEC 62253:2011	3. a) IS 16077	
4. Building-integrated photovoltaics	4. a) Telangana	

## ABBREVIATION

<b>AC:</b>	Alternating current
<b>CPV:</b>	Concentrating solar photovoltaics
<b>DC:</b>	Direct current
<b>DH:</b>	Discharge Head
<b>DESCO:</b>	Distributed energy service company
<b>EPC:</b>	Engineering, procurement, and construction
<b>EV:</b>	Electric vehicle
<b>GW/GWh:</b>	Gigawatt/gigawatt-hour
<b>HP:</b>	HorsePower
<b>JNNSM:</b>	Jawaharlal Nehru National Solar Mission
<b>KVK:</b>	Krishi Vikas Kendra
<b>LCC:</b>	Life cycle cost
<b>PMKUSUM:</b>	Pradhan Mantri Kisan Urja Suraksha Evam Utthan Mahabhiyan
<b>Kw/ Kwh:</b>	Kilowatt/kilowatt-hour
<b>MW/MWh:</b>	Megawatt/megawatt-hour
<b>MPPT:</b>	Maximum power point tracker
<b>MNRE</b>	Ministry of New and Renewable Energy
<b>NABARD:</b>	National Bank for Agriculture and Rural Development / PAYG Pay-as-you-go—a financing model involving payments for use to the service provider
<b>PMKSY:</b>	Pradhan Mantri Krishi Sinchai Yojana
<b>PV:</b>	Photo Voltaic
<b>SWH:</b>	Solar water heater/heating
<b>SWP:</b>	Solar Water Pumps
<b>SH:</b>	Suction Head
<b>SNA:</b>	State Nodal Agency
<b>TH:</b>	Total Head
<b>UID:</b>	Unique Identification Number
<b>VFD:</b>	variable-frequency drive
<b>W/Wh:</b>	Watt/watt-hour
<b>Wp:</b>	Peak Watt, also known as Watt-peak

## GLOSSARY

**Alternating Current (Ac)** — A type of electrical current, the direction of which is reversed at regular intervals or cycles.

**Ampere (Amp)** — A unit of electrical current or rate of flow of electrons.

**The angle of Incidence** — The angle that a ray of sun makes with a line perpendicular to the surface.

**Array** — Photovoltaic cells which are then grouped together to make solar panels.

**Battery** — Two or more electrochemical cells enclosed in a container and electrically interconnected in an appropriate series/parallel arrangement to provide the required operating voltage and current levels. Under common usage, the term battery also applies to a single cell if it constitutes the entire electrochemical storage system.

**Battery Capacity** — The maximum total electrical charge, expressed in ampere-hours, which a battery can deliver to a load under a specific set of conditions.

**Battery Cell** — The simplest operating unit in a storage battery.

**Battery Life** — The period during which a cell or battery is capable of operating above a specified capacity or efficiency performance level. Life may be measured in cycles and/or years, depending on the type of service for which the cell or battery is intended.

**Bypass Diode** — A diode connected across one or more solar cells in a photovoltaic module such that the diode will conduct if the cell(s) become reverse-biased. It protects these solar cells from thermal destruction.

**Charge Controller** — A component of a photovoltaic system that controls the flow of current to and from the battery to protect it from over-charge and over-discharge.

**Conductor** — The material through which electricity is transmitted, such as an electrical wire, or transmission or distribution line.

**Crystalline Silicon** — A type of photovoltaic cell made from a slice of single-crystal silicon or polycrystalline silicon.

**Electric Current** — The flow of electrical energy (electricity) in a conductor, measured in amperes.

**Gigawatt (GW)** — A unit of power equal to 1 billion watts; 1 million kilowatts, or 1,000 megawatts.

**Load** — The demand on an energy-producing system.

**Ohm** — A measure of the electrical resistance of a material equal to the resistance of a circuit in which the potential difference of 1 volt produces a current of 1 ampere.

**Parallel Connection** — A way of joining solar cells or photovoltaic modules by connecting positive leads together and negative leads together; such a configuration increases the current, but not the voltage.

**Photoelectric Cell** — A device for measuring light intensity that works by converting light falling on, or reach it, to electricity, and then measuring the current; used in photometers

**Photovoltaic (PV) Effect** — The phenomenon that occurs when photons, the “particles” in a beam of light, knock electrons loose from the atoms they strike.

**Resistance (R)** — The property of a conductor, which opposes the flow of an electric current.

**Stand-Alone System** — An autonomous or hybrid photovoltaic system not connected to a grid. may or may not have storage, but most stand-alone systems require batteries or some other form of storage.

**Standard Test Conditions (STC)** — Conditions under which a module is typically tested in a laboratory.

**String** — Several photovoltaic modules or panels interconnected electrically in series to produce the operating voltage required by the load.

**Tilt Angle** — The angle at which a photovoltaic array is set to face the sun relative to a horizontal position. The tilt angle can be set or adjusted to maximize seasonal or annual energy collection.

**Watt** — The rate of energy transfer equivalent to one ampere under an electrical pressure of one volt. One watt equals 1/746 horsepower or one joule per second. It is the product of voltage and current (amperage).

## **List of Credits**